

# Lubricant pump P203 for multi-line lubrication systems DC versions with control PCB V10-V23

Assembly instructions  
following machinery directive 2006/42/EC

EN

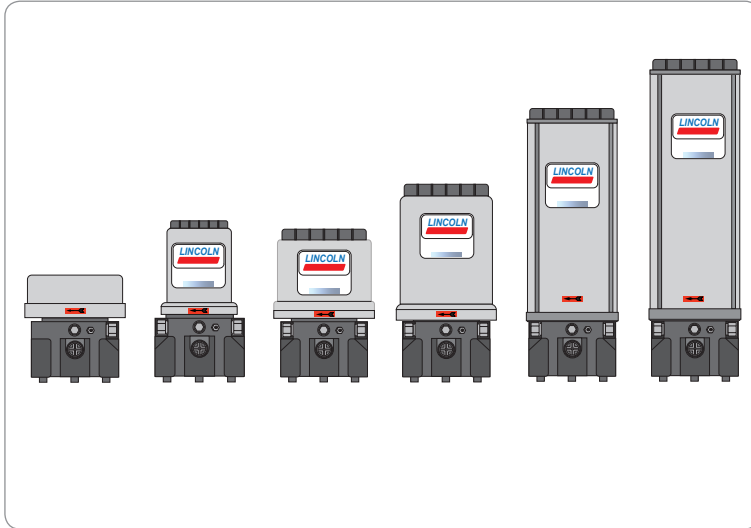

951-171-023-EN  
Version 01  
28/03/2018



## EC Declaration of incorporation acc. to machinery directive 2006/42/EC

The manufacturer, SKF Lubrication Systems Germany GmbH, Walldorf Facilities, Heinrich-Hertz-Str. 2-8, DE - 69190 Walldorf, hereby declares that the partly completed machinery

Designation: Electrically driven pump to supply lubricant during intermittent operation within a centralized lubrication system  
 Type: P203 V DC  
 Part number: 644-xxxx-x / x94xxxxxx  
 Year of construction: See type identification plate

complies with the following basic safety and health requirements of the EC machinery directive 2006/42/EC at the time when first being launched in the market.

1.1.2 · 1.1.3 · 1.3.2 · 1.3.4 · 1.5.6 · 1.5.8 · 1.5.9 · 1.6.1 · 1.7.1 · 1.7.3 · 1.7.4

The special technical documents were prepared following Annex VII part B of this directive. Upon justifiable request, these special technical documents can be forwarded electronically to the respective national authorities. The person empowered to assemble the technical documentation on behalf of the manufacturer is the head of standardization, See manufacturer's address.

Furthermore, the following directives and harmonized standards were applied in the respective applicable areas:

2011/65/EU ECE-R10	RoHS II				
	Electromagnetic compatibility	automotive			
Standard	Edition	Standard	Edition	Standard	Edition
ISO 12100	2011	EN 50581	2013	EN 61000-6-2	2006
EN 809	2012	EN 61131-2	2008	Amendment	2011
EN 60204-1	2007	Amendment	2009	EN 61000-6-4	2011
Amendment	2010	EN 60034-1	2011		

The partly completed machinery must not be put into service until the final machinery into which it is to be incorporated has been declared in conformity with the provisions of machinery directive 2006/42/EC and any other applicable directives.

Walldorf, 28/03/2018

Jürgen Kreuzkämper  
 Manager R&D Germany  
 SKF Lubrication Systems  
 Germany GmbH



Stefan Schürmann  
 Manager R&D Hockenheim/Walldorf  
 SKF Lubrication Systems  
 Germany GmbH



## Legal disclosure

### Manufacturer

SKF Lubrication Systems Germany GmbH  
e-mail: [Lubrication-germany@skf.com](mailto:Lubrication-germany@skf.com)  
[www.skf.com/lubrication](http://www.skf.com/lubrication)

### Manufacturer's addresses

#### Walldorf Facilities

Heinrich-Hertz-Straße 2-8  
69190 Walldorf  
Germany  
Phone: +49 (0) 6227 33-0  
Fax: +49 (0) 6227 33-259

#### Berlin Facilities

Motzener Straße 35/37  
12277 Berlin  
Germany  
Phone +49 (0)30 72002-0  
Fax +49 (0)30 72002-111  
[www.skf.com/lubrication](http://www.skf.com/lubrication)

#### Hockenheim Facilities

2. Industriestraße 4  
68766 Hockenheim  
Germany  
Phone +49 (0)62 05 27-0  
Fax +49 (0)62 05 27-101

### Training courses

In order to provide a maximum of safety and economic viability, SKF carries out detailed training courses. It is recommended that the training courses are attended. For more information please contact the respective SKF Service address.

### Copyright

© Copyright SKF  
All rights reserved.

### Warranty

The instructions do not contain any information on the warranty. This can be found in our general terms and conditions.

### Service address North America

SKF Lubrication Business Unit  
Lincoln Industrial  
5148 North Hanley Road, St. Louis,  
MO. 63134 USA

### Disclaimer

The manufacturer shall not be held responsible for damages caused by:

- Non appropriate use  
faulty assembly, operation, setting, maintenance, repair or accidents
- Use of inappropriate lubricants
- Improper or late response to malfunctions
- Unauthorized modifications of the product
- Intent or negligence
- Use of non-original SKF spare parts
- Faulty planning or layout of the centralized lubrication system

Liability for loss or damage resulting from the use of our products is limited to the maximum purchase price. Liability for consequential damages of whatever kind is excluded.

## Table of contents

EC Declaration of incorporation acc. to machinery directive 2006/42/EC .....	2
Legal disclosure.....	3
Explanation of symbols, signs and abbreviations.....	7
<b>1. Safety instructions.....</b>	<b>9</b>
1.1 General safety instructions.....	9
1.2 General behaviour when handling the product.....	9
1.3 Intended use.....	10
1.4 Foreseeable misuse.....	10
1.5 Modifications of the product.....	10
1.6 Prohibition of certain activities.....	10
1.7 Painting of plastic parts.....	10
1.8 Notes related to the CE marking.....	11
1.9 Inspections prior to delivery.....	11
1.10 Other applicable documents.....	11
1.11 ADR test certificate.....	11
1.12 Markings on the product.....	12
1.13 Notes related to the type identification plate.....	12
1.13.1 UL approval mark.....	12
1.13.2 ECE approval mark.....	12
1.14 Persons authorized to operate the pump.....	13
1.14.1 Operator.....	13
1.14.2 Specialist in mechanics.....	13
1.14.3 Specialist in electrics.....	13
1.15 Briefing of external technicians.....	13
1.16 Provision of personal protective equipment.....	13
1.17 Operation.....	13
1.18 Emergency stopping.....	13
1.19 Transport, installation, maintenance, malfunctions, repair, shutdown, disposal.....	14
1.20 Initial commissioning / daily start-up.....	15
1.21 Cleaning.....	15
1.22 Residual risks.....	16
<b>2. Lubricants.....</b>	<b>17</b>
2.1 General information.....	17
2.2 Selection of lubricants.....	17
2.3 Material compatibility.....	17
2.4 Temperature characteristics.....	17
2.5 Ageing of lubricants.....	18
2.6 Chisel pastes.....	19
2.6.1 Solid lubricants.....	19
<b>3. Overview, functional description.....</b>	<b>20</b>
3.1 Pumps without follower plate.....	20
3.2 Pumps with follower plate.....	23
<b>4. Technical data.....</b>	<b>25</b>
4.1 General technical data.....	25
4.2 Protection types and classes.....	26
4.3 Hydraulic connection diagram.....	26
4.4 Nominal output volumes.....	27































4.4.1	Influencing variables on the output volume .....	27	5.5.1	Storage period of up to 6 months .....	42
4.4.2	Output diagrams of typical NLGI 2 lubricants .....	28	5.5.2	Storage period from 6 to 18 months .....	42
4.5	Functioning principle of the intermittent low-level indication .....	29	5.5.3	Storage period exceeding 18 months .....	42
4.6	Limits of use of the intermittent low-level indication .....	30			
4.7	Processing of the low-level signals in case of external controller and monitoring of the pump .....	31	<b>6.</b>	<b>Installation .....</b>	<b>43</b>
4.7.1	Visualization of a low-level indication .....	31	6.1	General information .....	43
4.7.2	Remaining run time of pump in case of a low-level indication .....	31	6.2	Place of installation .....	43
4.8	Reservoir versions .....	32	6.3	Mechanical connection .....	44
4.9	Useable reservoir volume .....	33	6.3.1	Minimum assembly dimensions .....	44
4.10	Lubricant requirement for priming of an empty pump .....	34	6.3.2	Installation bores .....	47
4.11	Tightening torques .....	35	6.4	Electrical connection .....	49
4.12	Factory settings of the lubrication and pause times of pumps with control PCB V10-V23 .....	36	6.5	Adjusting the output volume on the pump element R .....	51
4.13	Possible settings of the lubrication and pause times of pumps with control PCB V10-V23 .....	36	6.6	Mount pressure control valve .....	52
4.14	Type identification code .....	37	6.7	Lubrication line connection .....	53
<b>5.</b>	<b>Delivery, returns, and storage .....</b>	<b>41</b>	6.8	Filling with lubricant .....	54
5.1	Delivery .....	41	6.8.1	Filling via the reservoir lid .....	54
5.2	Returns .....	41	6.8.2	Filling via filler fitting .....	55
5.3	Storage .....	41	6.8.3	Filling via the optional filling connection .....	56
5.4	Storage temperature range .....	41	6.9	Setting of lubrication and pause times .....	57
5.5	Storage conditions for parts filled with lubricant .....	42	6.10	Changing the lubrication and pause times via jumper setting .....	58
			<b>7.</b>	<b>Initial start-up .....</b>	<b>59</b>
			7.1	Inspections prior to initial start-up .....	59

7.2	Inspections during initial start-up .....	59	14.	<b>Spare parts .....</b>	<b>74</b>
7.3	Acknowledge receipt of a fault indication .....	60	14.1	Housing cover assy. ....	74
7.4	Triggering an additional lubrication cycle.....	62	14.2	Pump elements.....	74
<b>8.</b>	<b>Operation .....</b>	<b>63</b>	14.3	Pressure control valve and adapter .....	75
8.1	Refill lubricant .....	63	14.4	Adapter D 6 AX 1/8NPT I C .....	75
<b>9.</b>	<b>Cleaning .....</b>	<b>64</b>	14.5	Motor 12/ 24 V DC .....	75
9.1	Cleaning agents.....	64	14.6	Magnetic switch normally open (NO).....	76
9.2	Exterior cleaning .....	64	14.7	Adapter with lubrication fitting.....	76
9.3	Interior cleaning .....	64	14.8	Closure screw M22 x 1,5.....	76
<b>10.</b>	<b>Maintenance .....</b>	<b>65</b>	14.9	Transparent reservoir.....	77
<b>11.</b>	<b>Troubleshooting .....</b>	<b>66</b>	14.10	Replacement kit control PCB .....	78
11.1	Display of the operating states and fault conditions by means of the control PCB's LEDs .....	68	14.11	Fixed paddle.....	79
<b>12.</b>	<b>Repairs.....</b>	<b>69</b>	14.12	Reservoir lid.....	79
12.1	Check pump element and replace pressure control valve .....	69	14.13	Screw cap.....	79
12.2	Replacement of the control PCB .....	70	14.14	Connection sockets and cable .....	80
12.3	Installation of the pump at the place of use.....	71	<b>15.</b>	<b>Electrical connections .....</b>	<b>81</b>
12.4	Tests after replacement of the control PCB .....	72	15.1	Cable colours following IEC 60757 .....	81
<b>13.</b>	<b>Shutdown and disposal.....</b>	<b>73</b>	15.2	Connection of signal line to reservoir lid .....	82
13.1	Temporary shutdown .....	73	15.3	Recommended contact protection measure for switching inductive loads	83
13.2	Final shutdown and disassembly .....	73	15.4	Connection diagram P203 V DC with control PCB V, 1 of 6 .....	84
13.3	Disposal.....	73	15.5	Connection diagram P203 V DC with control PCB V, 2 of 6 .....	85
			15.6	Connection diagram P203 V DC with control PCB V, 3 of 6 .....	86
			15.7	Connection diagram P203 V DC with control PCB V, 4 of 6 .....	87
			15.8	Connection diagram P203 V DC with control PCB V, 5 of 6 .....	88
			15.9	Connection diagram P203 V DC with control PCB V, 6 of 6 .....	89

## Explanation of symbols, signs and abbreviations

The following abbreviations may be used within these instructions. Symbols within safety notes mark the kind and source of the hazard.

	General warning		Dangerous electrical voltage		Risk of falling		Hot surfaces
	Unintentional intake		Crushing hazard		Pressure injection		Suspended load
	Electrostatically sensitive components		Potentially explosive atmosphere		Keep unauthorized persons away		Wear personal protective equipment (protective clothes)
	Wear personal protective equipment (goggles)		Wear personal protective equipment (face shield)		Wear personal protective equipment (gloves)		
	Wear personal protective equipment (safety shoes)		Disconnect product from mains		General obligation		Safe galvanic isolation (protection class III)
	Protective conductor (protection class)		Protection by double or reinforced insulation (protection class II)		Protection by extra low voltage (protection class III)		
	CE marking		Disposal, recycling		Disposal of waste electrical and electronic equipment		

	Warning level	Consequence	Probability	Symbol	Meaning
	<b>DANGER</b>	Death, serious injury	imminent	●	Chronological guidelines
	<b>WARNING</b>	Death, serious injury	possible	○	Lists
	<b>CAUTION</b>	Minor injury	possible	☞	Refers to other facts, causes, or consequences
	<b>NOTICE</b>	Property damage	possible		

## Abbreviations and conversion factors

re.	regarding	°C	degrees Celsius	°F	degrees Fahrenheit
approx.	approximately	K	Kelvin	Oz.	ounce
i.e.	that is	N	Newton	fl. oz.	fluid ounce
poss.	possibly	h	hour	in.	inch
if appl.	if applicable	s	second	psi	pounds per square inch
incl.	including	d	day	sq. in.	square inch
min.	minimum	Nm	Newtonmeter	cu. in.	cubic inch
max.	maximum	ml	millilitre	mph	miles per hour
min.	minute	ml/d	millilitre per day	rpm	revolutions per minute
etc.	et cetera	cc	cubic centimetre	gal.	gallon
e.g.	for example	mm	millimetre	lb.	pound
kW	kilowatt	l	litre	hp	horse power
U	voltage	dB (A)	sound pressure level	kp	kilopond
R	resistance	>	greater than	fpsec	feet per second
I	current	<	less than	conversion factors	
V	volt	±	plus/minus	Length	1 mm = 0.03937 in.
W	watt	∅	diameter	Area	1 cm <sup>2</sup> = 0.155 sq.in
AC	alternating current	kg	kilogram	Volume	1 ml = 0.0352 fl.oz.
DC	direct current	rh	relative humidity		1 l = 2.11416 pints (US)
A	ampere	≈	approximately	Mass	1 kg = 2.205 lbs
Ah	ampere hour	=	equal to		1 g = 0.03527 oz.
Hz	frequency [Hertz]	%	per cent	Density	1 kg/cc = 8.3454 lb./gal.(US)
nc	normally closed contact	‰	per mille		1 kg/cc = 0.03613 lb./cu.in.
no	normally open contact	≥	greater than	Force	1 N = 0.10197 kp
N/A	not applicable	≤	less than	Pressure	1 bar = 14.5 psi
ft.	feet	mm <sup>2</sup>	square millimetre	Temperature	°C = (°F-32) x 5/9
		rpm	revolutions per minute	Output	1 kW = 1.34109 hp
		↑	Increases a value	Acceleration	1 m/s <sup>2</sup> = 3.28084 ft./s <sup>2</sup>
		↓	Reduces a value	Speed	1 m/s = 3.28084 fpsec.
					1 m/s = 2.23694 mph

# 1. Safety instructions

## 1.1 General safety instructions

- The owner must ensure that safety information has been read by any persons entrusted with works on the product or by those persons who supervise or instruct the before-mentioned group of persons. In addition, the owner must also ensure that the relevant personnel are fully familiar with and have understood the contents of the Instructions. It is prohibited to commission or operate the products prior to reading the instructions
- These instructions must be kept for further use
- The described products were manufactured according to the state of the art. Risks may, however, arise from a usage not according to the intended purpose and may result in harm to persons or damage to material assets
- Any malfunctions which may affect safety must be remedied immediately. In addition to these Instructions, general statutory regulations for accident prevention and environmental protection must be observed

## 1.2 General behaviour when handling the product

- The product may be used only in awareness of the potential dangers, in proper technical condition, and according to the information in these instructions
- Familiarize yourself with the functions and operation of the product. The specified assembly and operating steps and their sequences must be observed
- Any unclear points regarding proper condition or correct assembly/ operation must be clarified. Operation is prohibited until issues have been clarified
- Keep unauthorized persons away
- Wear personal protective equipment always
- Precautionary operational measures and instructions for the respective work must be observed
- Responsibilities for different activities must be clearly defined and observed. Uncertainty seriously endangers safety
- Safety-related protective and safety equipment must not be removed, modified or affected otherwise in its function and is to be checked at regular intervals for completeness and function
- If protective and safety equipment has to be dismantled, it must be reassembled immediately after finishing the work, and then checked for correct function
- Remedy occurring faults in the frame of responsibilities. Immediately inform your superior in the case of faults beyond your competence
- Never use parts of the centralized lubrication system or of the machine as standing or climbing aids

### 1.3 Intended use

Supply of lubricants within a centralized lubrication system following the specifications, technical data and limits stated in these Instructions:

Usage is allowed exclusively for professional users in the frame of commercial and economic activities.

### 1.4 Foreseeable misuse

Any usage differing from the one stated in these Instructions is strictly prohibited, particularly a usage:

- outside the indicated ambient temperature range
- with non-specified means of operation
- without adequate pressure control valve
- in continuous operation
- of C3 versions in areas with aggressive and corrosive materials (e.g. with high salt concentration)
- of plastic parts in areas with high ozone levels or in areas with harmful radiation (e.g. ionising radiation)

- to supply, transport, or store hazardous substances and mixtures in accordance with annex I part 2-5 of the CLP regulation (EG 1272/2008) or HCS 29 CFR 1910.1200 marked with GHS01-GHS06 and GHS08 hazard pictograms
- to feed, forward, or store gases, liquefied gases, dissolved gases, vapours, or fluids whose vapour pressure exceeds normal atmospheric pressure of 1013 mbar [14.69 psi] by more than 0.5 bar [7.25 psi] at the maximum permissible operating temperature.
- in an explosion protection zone

### 1.5 Modifications of the product

Unauthorized conversions or modifications may result in unforeseeable impacts on safety. Therefore, any unauthorized conversions or modifications are expressly prohibited.

### 1.6 Prohibition of certain activities

Due to potential sources of faults that may not be visible or due to legal regulations the following activities may be carried out by manufacturer specialists or authorized persons only:

- Repairs or changes to the drive
- Replacement of or changes on the pistons of the pump elements
- Changes on the control printed circuit board exceeding adjustment of the lubrication and pause times or the replacement in case of defects.

### 1.7 Painting of plastic parts

Painting of any plastic parts or seals of the described products is expressly prohibited. Remove or tape plastic parts completely before painting the superior machine

### 1.8 Notes related to the CE marking

CE marking is effected following the requirements of the applied directives:

- 2014/30/EU  
Electromagnetic compatibility
- 2011/65/EU  
(RoHS II) Directive on the restriction of the use of certain hazardous substances in electrical and electronic equipment

Reference on Pressure Equipment Directive 2014/68/EU

Because of its performance data the product does not achieve the limit values defined in Article 4 (1) (a) (i) and is therefore excluded from the scope of application of Pressure Equipment Directive 2014/68/EU following Article 4 (3).

### 1.9 Inspections prior to delivery

The following inspections were carried out prior to delivery:

- Safety and functional tests
- Electrical inspections following ISO 60204-1

### 1.10 Other applicable documents

In addition to these instructions, the following documents must be observed by the respective target group:

- Operational instructions and approval rules
- Safety data sheet of the lubricant used

Where appropriate:

- Project planning documents
- Additional information on special versions of the pump. You will find these in the special system documentation
- Any documents of other components required to set up the centralized lubrication system

### 1.11 ADR test certificate

Provided the use of ADR connecting material as stated in the type identification code and correctly performed electrical installation, the lubricant pumps comply with ADR requirements for use outside potentially explosive zones 0, 1 or 2 in vehicle types EX/II, EX/III, FL and AT.

Test institute:  
TÜV-SÜD Auto Service GmbH

Component approval marking:  
TU.EGG.054-01

### 1.12 Markings on the product



Warning of unintended intake by the stirring paddle with the reservoir lid being open



Warning of spring tension in case of pumps with follower plates



Rotational direction of the pump

**ADR**  
TÜ.EGG.054-01

Pumps with ADR approval



Further to the findings of the workplace risk evaluation the operating company has to attach additional markings (e. g. warnings, signs giving orders, prohibition signs or labelling as specified by GHS), where appropriate.

### 1.13 Notes related to the type identification plate

The type identification plate states important characteristics such as type designation, order number, and regulatory characteristics.

To ensure that the loss of data due to an illegible type identification plate is avoided, the characteristics should be entered in the Instructions.

Model: \_\_\_\_\_

P. No. \_\_\_\_\_

S. No. \_\_\_\_\_

(CW/YY) \_\_\_\_\_

Calendar week/year of construction

#### 1.13.1 UL approval mark

The UL approval mark confirms conformity of the product with applicable safety regulations of the USA and Canada.

#### 1.13.2 ECE approval mark

The ECE approval mark (E1) confirms that an ECE design certification (ECE R10) was issued for the product.

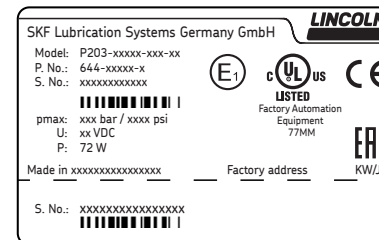
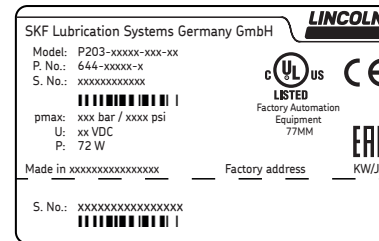



### 1.14 Persons authorized to operate the pump

#### 1.14.1 Operator

A person who is qualified by training, knowledge and experience to carry out the functions and activities related to normal operation. This includes avoiding possible hazards that may arise during operation.

#### 1.14.2 Specialist in mechanics

Person with appropriate professional education, knowledge and experience to detect and avoid the hazards that may arise during transport, installation, start-up, operation, maintenance, repair and disassembly.

#### 1.14.3 Specialist in electrics

Person with appropriate professional education, knowledge and experience to detect and avoid the hazards that may arise from electricity.

### 1.15 Briefing of external technicians

Prior to commencing the activities, external technicians must be informed by the operator of the company safety provisions, the applicable accident prevention regulations to be maintained, and the functions of the superordinate machine and its protective devices.

### 1.16 Provision of personal protective equipment

The operator must provide suitable personal protective equipment for the respective location of operation and the purpose of operation.

### 1.17 Operation

The following must be observed during commissioning and operation:

- Any information within this manual and the information within the referenced documents
- All laws and regulations to be complied with by the user

### 1.18 Emergency stopping

In case of an emergency stop the pump station by:

- Interrupting the power supply to the pump
- Where appropriate, using measures determined by the operator, such as actuating the emergency stop switch of the superior machine

### 1.19 Transport, installation, maintenance, malfunctions, repair, shutdown, disposal

- All relevant persons must be informed of the activity prior to starting any work. Observe the precautionary operational measures and work instructions
- Carry out transport using suitable transport and hoisting equipment on suitable ways only
- Maintenance and repair work can be subject to restrictions at low or high temperatures (e.g. changed flow properties of the lubricant). Therefore, where possible, try to carry out maintenance and repair work at room temperature
- Prior to performing work, the product and the machine, into which the product will be integrated, must be depressurized and secured against unauthorized activation
- Ensure through suitable measures that movable or detached parts are immobilized during the work and that no limbs can be caught in between by inadvertent movements
- Assemble the product only outside of the operating range of moving parts, at an adequate distance from sources of heat or cold. Other units of the machine or vehicle must not be damaged or impaired in their function by the installation
- Dry or cover wet, slippery surfaces accordingly
- Cover hot or cold surfaces accordingly
- Work on electrical components must be carried out by electrical specialists only. Observe any waiting periods for discharging, if necessary
- Carry out works on electrical components only while the system is depressurized and use voltage isolated tools suitable for electrical works only
- Carry out electrical connections only according to the information in the valid wiring diagram and taking the relevant regulations and the local connection conditions into account
- Do not touch cables or electrical components with wet or damp hands
- Fuses must not be bypassed Replace defective fuses always by fuses of the same type
- Ensure proper connection of the protective conductor in case of products of protection class I
- Observe the stated type of protection
- Undertake drilling at non-critical, non-load bearing parts only. Use any available boreholes. Do not damage lines and cables when drilling
- Observe possible abrasion points. Protect the parts accordingly

- All components used must be designed according to the maximum operating pressure and the maximum respectively minimum ambient temperature
- No parts of the centralized lubrication system may be subjected to torsion, shear, or bending
- Check all parts prior to their usage for contamination and clean, if necessary
- Lubricant lines must be primed with lubricant prior to installation. This makes the subsequent ventilation of the system easier
- Observe the specified tightening torques. When tightening, use a calibrated torque wrench
- When working with heavy parts use suitable lifting tools
- Avoid mixing up or wrong assembly of dismantled parts. Mark these parts accordingly

### 1.20 Initial commissioning / daily start-up

Ensure that:

- All safety devices are completely available and functional
- All connections are correctly connected
- All parts are correctly installed
- All warning labels on the product are present completely, highly visible and undamaged
- Illegible or missing warning labels are to be replaced without delay

### 1.21 Cleaning

- Risk of fire and explosion when using inflammable cleaning agents Only use non-flammable cleaning agents suitable for the purpose
- Do not use aggressive cleaning agents
- Thoroughly remove residues of cleaning agents from the product
- Do not use steam jet and high pressure cleaners. Electrical components may be damaged. Observe the type of protection of the pump
- Cleaning work may not be carried out on energized components
- Mark damp areas accordingly

## 1.22 Residual risks

Residual risk	Possible in life cycle											Prevention/ remedy	
Personal injury/ material damage due to falling of raised parts	A	B	C					G	H	K			Keep unauthorized persons away No people may remain under suspended loads. Lift parts with adequate lifting devices.
Personal injury/ material damage due to tilting or falling of the product because of non-observance of the stated tightening torques		B	C					G					Observe the specified tightening torques. Fix the product to components with adequate load-bearing capacities only. If no tightening torques are stated, apply tightening torques according to the screw size characteristics for 8.8 screws.
Personal injury/ material damage due to electric shock in case of damage to the connection cable		B	C	D	E	F	G	H					Check the connection cable with regard to damages before the first usage and then at regular intervals. Do not mount cable to moving parts or friction points. If this cannot be avoided, use spring coils respectively protective conduits.
Personal injury/ damage to material due to spilled or leaked lubricant		B	C	D		F	G	H	K				Be careful when filling the reservoir and when connecting or disconnecting lubricant feed lines. Always use suitable hydraulic screw connections and lubrication lines for the stated pressures. Do not mount lubrication lines to moving parts or friction points. If this cannot be avoided, use spring coils respectively protective conduits.
Loss of electrical protective function due to faulty installation of electrical components after repair							G						After replacement of electrical components carry out an electrical safety test according to ISO 60204-1.
Reservoir with follower plate is subjected to spring load							G						Remove reservoir with follower plate only when the spring is quite released (i.e. the reservoir is empty). Provide adequate protective measure, e.g. fastening straps, when loosening the reservoir. Do not work with your head directly above the reservoir.
Life phases: A = transport, B = installation, C = initial start-up, D = operation, E = cleaning, F = maintenance, G = fault, repair, H = shutdown, K = disposal													

## 2. Lubricants

### 2.1 General information

Lubricants are used specifically for certain application purposes. In order to fulfil their tasks, lubricants must fulfil various requirements.

The most important requirements for lubricants are:

- Reduction of abrasion and wear
- Corrosion protection
- Noise minimisation
- protection against contamination or penetration of foreign objects
- Cooling (primarily with oils)
- longevity (physical/ chemical stability)
- economic and ecological aspects

### 2.2 Selection of lubricants

SKF considers lubricants to be an element of system design. A suitable lubricant is selected already when designing the machine and forms the basis for the planning of a centralized lubrication system.

The selection is made by the manufacturer or operator of the machine, preferably together with the lubricant supplier based on the requirement profile defined.

Should you have little or no experience with the selection of lubricants for centralized lubrication systems, please contact SKF.

If required we will be glad to support customers to select suitable components for feeding the selected lubricant and to plan and design their centralized lubrication system.

You will avoid possible downtimes through damage to your machine or system or damage to the centralized lubrication system.

### 2.3 Material compatibility

Lubricants must generally be compatible with the following materials:

- steel, grey iron, brass, copper, aluminium
- NBR, FPM, ABS, PA, PUR

### 2.4 Temperature characteristics

The lubricant used must be suitable for the specific ambient temperature of the product. The viscosity required for proper operation of the product must be adhered to and must not be exceeded in case of low temperatures nor fall below specification in case of high temperatures. Specified viscosities, see chapter Technical data.

## 2.5 Ageing of lubricants

After a prolonged downtime of the machine, the lubricant must be inspected prior to re-commissioning as to whether it is still suitable for use due to chemical or physical ageing. We recommend that you undertake this inspection already after a machine downtime of 1 week.

If doubts arise as to a further suitability of the lubricant, please replace it prior to re-commissioning and, if necessary, undertake initial lubrication by hand.

It is possible for lubricants to be tested in the company's laboratory for their suitability for being pumped in centralized lubrication systems (e.g. "bleeding").

Please contact SKF, if you have further questions regarding lubricants.

You may request an overview of the lubricants tested by SKF.



Only lubricants specified for the product (see chapter Technical data) may be used. Unsuitable lubricants may lead to a failure of the product.



Do not mix lubricants. This may have unforeseeable effects on the usability and therefore on the function of the centralized lubrication system.



When handling lubricants the relevant safety data sheets and hazard designations, if any, on the packaging have to be observed.



Due to the multitude of possible additives, individual lubricants, which according to the manufacturer's data sheets fulfil the necessary specification, may not, in fact, be suitable for use in centralized lubrication systems (e. g. incompatibility between synthetic lubricants and materials). In order to avoid this, always use lubricants tested by SKF.

## 2.6 Chisel pastes

### NOTICE

#### Damage to the superior machine

Chisel pastes must not be used as a lubricant for bearings.

### NOTICE

#### Damage of the centralized lubrication system

Chisel pastes may be supplied by pump element C only. Hereby the maximum operating pressure must not exceed 200 bar [2900 psi], as otherwise the solid lubricants contained in the chisel paste may cause increased wear.

### 2.6.1 Solid lubricants



Solid lubricants may be used only upon prior consultation of SKF Lubrications Systems.

With regard to the different solid lubricants contained in chisel pastes, please observe the following:

#### Graphite

max. graphite content 8 %  
max. particle size 25 µm  
(possibly in in lamellar structure)

#### MoS<sub>2</sub>

max. MoS<sub>2</sub> content 5 %  
max. particle size 15 µm

#### Copper

Chisel pastes containing copper are likely to result in a layer formation on pistons, bores and mating surfaces. This may cause blockages in the centralized lubrication system.

#### Calcium carbonate

Chisel pastes containing calcium carbonate are likely to cause a very strong wear on pistons, bores and mating surfaces.

#### Calcium hydroxide

Chisel pastes containing calcium hydroxide are likely to harden strongly, what may result in a downtime of the centralized lubrication system.

#### PTFE, zinc and aluminium

Due to the findings and practical experiences gained so far, no limit values can be set for these solid lubricants yet.

### 3. Overview, functional description

#### 3.1 Pumps without follower plate

##### 1 Reservoir

The lubricant is stored in the reservoir. Depending on the pump version there are different types of reservoirs and reservoir sizes.

##### 1.1 Reservoir lid

Serves to fill the reservoir with suitable clean lubricant and as a protection against contamination of the lubricant.

##### 1.2 Reservoir venting device

It provides air for the reservoir while the pump is operating and lubricant is supplied.

##### 10 Stirring paddle

While the pump operates, the stirring paddle homogenises and smoothes the lubricant. The stirring paddle's lower vertical part pushes the lubricant towards the pump elements thus improving the suction behaviour of the pump.

Overview, functional description of pumps without follower plate Fig. 1





**2 Pump housing**

The pump housing accommodates the motor, the electrical connections, the filler fitting, the pump elements, the control PCB and, if need be, the intermittent low-level indication.

**3 pump elements**

The pump can be equipped with up to 3 pump elements.

**4 Filler fitting**

Serves to fill the pump from the bottom. If the filler fitting is removed, this port can be used to connect the external grease return from the pressure control valves to the pump elements with corresponding accessories.

**5 Electrical connections**

They are used for (5.1) power supply (input) and for (5.2) signal connection (output) of the pump. According to the specific pump version the electrical connections come as square plugs, bayonet plugs or as screwed cable gland with Deutsch plug.

Overview, functional description of pumps without follower plate Fig. 2



## Types of connections

## Square plug



## Bayonet plug

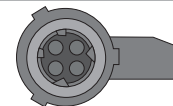

## Screwed cable gland with cable and Deutsch plug

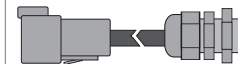

### 9 Screw cap of control PCB

The screw cap (9) allows to see the operating or error states (LED displays on the control PCB).

Remove the screw cap (9) by turning it anti-clockwise to trigger an additional lubrication or to adjust lubrication and pause times on the control PCB. Then tighten the screw cap again by applying the stated tightening torque.

### 11 Control PCB

The control PCB is seated behind the screw cap. After removing the screw cap it is possible to adjust the lubrication time (jumper) and the pause time (blue rotary switch) or to trigger an additional lubrication (pushbutton). The control PCB is equipped with an EEPROM. Thus the PCB's data are protected against loss.

Overview, functional description of the control PCB Fig. 3

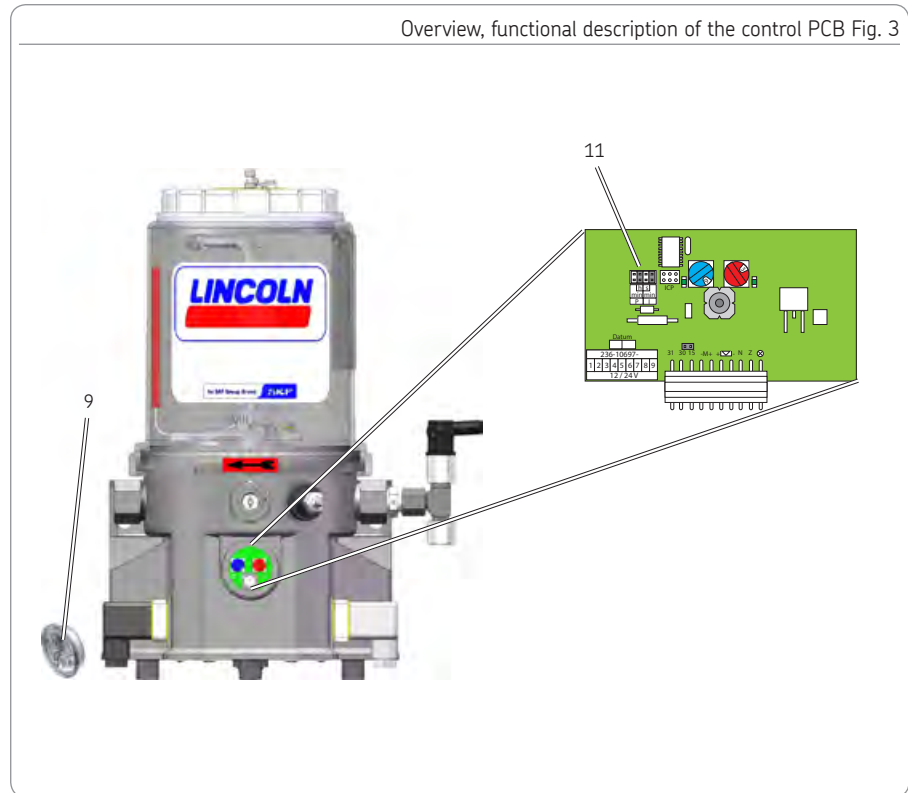

### 3.2 Pumps with follower plate

#### 1 Reservoir

The lubricant is stored in the reservoir. Depending on the pump version there are different types of reservoirs and reservoir sizes.

#### 1.2 Reservoir venting device

It provides air for the reservoir while the pump is operating and lubricant is supplied. It vents the reservoir while the pump is filled.

#### 6 Follower plate

The follower plate (6) rests on the lubricant and presses it down in the direction of the pump elements by spring force. As a result the suction behaviour of the pump improves.

#### 7 Contact rod

The contact rod (7) of the follower plate accommodates the reed contacts for the low-level function. In the follower plate there is a magnet that actuates the reed contact when reaching a certain switch point. The reed contact for the low-level indication is positioned at the lower switch point.

Overview, functional description of pumps with follower plate Fig. 4

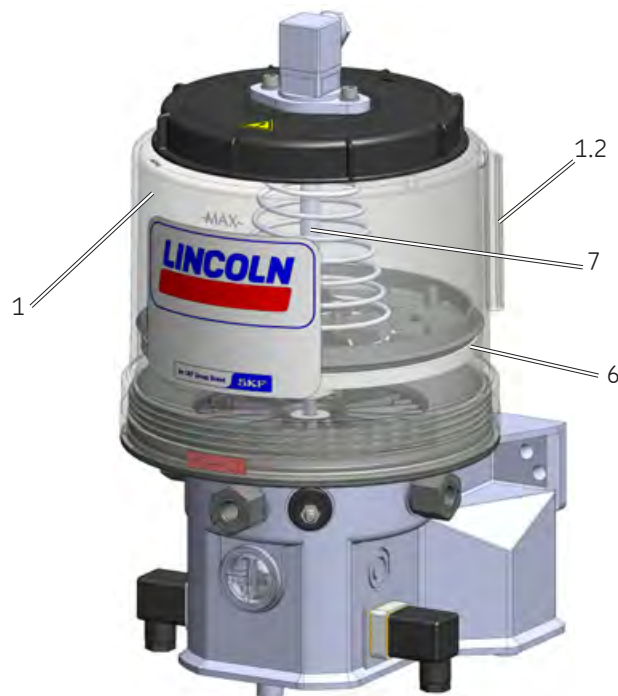

## 2 Pump housing

The pump housing accommodates the motor, the electrical connections, the filler fitting, the pump elements and the control PCB.

## 3 pump elements

The pump can be equipped with up to 3 pump elements.

## 4 Filler fitting

Serves to fill the pump. If the filler fitting is removed, this port can be used to connect the external grease return from the pressure control valves to the pump elements with corresponding accessories.

## 5 Electrical connections

Serve to provide (5.1) the power supply (input), to connect the filling level indications (5.3) in case of pumps with follower plate, and to provide (5.2) the signal connection (output) of the pump. According to the specific pump version the electrical connections come as square plugs, bayonet plugs or as screwed cable gland with cable and Deutsch plug.

Overview, functional description of pumps with follower plate Fig. 5



### Types of connections

#### Square plug



#### Bayonet plug

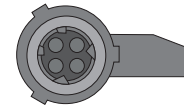

#### Screwed cable gland with cable and Deutsch plug

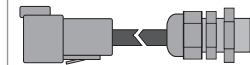

## 4. Technical data

### 4.1 General technical data

Operating pressure	max. 350 bar [5076 psi]	12 V DC pump	24 V DC pump
Number of pump elements	max. 3	Rated voltage	12 V DC $\pm$ 10 %
Direction of rotation	clockwise	Recommended back-up fuse	6.0 A (slow-blow)
Sound pressure level	< 70 dB (A)	Current consumption	6.5 A
Nominal speed	20 rpm	Output (signal)	non-isolated
Relative duty cycle	30 % ED S3 30 minutes	Max. switching capacity	60 VA
Ambient temperature <sup>1)</sup>	-40 °C to +70 °C [-40 °F to +158 °F]	Max. switching voltage	30 V DC
Installation position <sup>2)</sup>	vertical, i.e. reservoir at top.	Max. switching current	700 mA
Protection type and class	see next page		
Lubricants	<ul style="list-style-type: none"> <li>- Lubrication greases up to NLGI II</li> <li>- Lubrication oils of at least 40 mm<sup>2</sup>/s (cST) at ambient temperature</li> <li>- Chisel paste (see chapter Lubricants)</li> </ul>	Weight of the empty pump	
		2 litres approx. 6.5 kg	[0.53 gal. approx. 14.3 lbs.]
		4 litres approx. 9.0 kg	[1.06 gal. approx. 19.8 lbs.]
Filling	<ul style="list-style-type: none"> <li>- Filler fitting</li> <li>- Reservoir lid (for reservoirs without follower plate)</li> <li>- Optional filling connection</li> </ul>	8 litres approx. 10 kg	[2.11 gal. approx. 22.0 lbs.]
		11 litres, approx. 12 kg	[2.90 gal. approx. 26.5 lbs.]
		15 litres, approx. 14 kg	[3.96 gal. approx. 30.9 lbs.]

<sup>1)</sup> The minimum admissible ambient temperature assumes that the lubricant used can be pumped. The maximum admissible ambient temperature depends on the load and is mainly determined by the runtime and the operating pressure. In case of temperatures  $\geq 60^\circ\text{C}$  [140° F] and heavy load (high pressure) the maximum duty cycle should be reduced.

<sup>2)</sup> Pumps with follower plate allow for a rotating installation as well, e. g. in wind turbine generators. Maximum speed and maximum distance to the rotation axis on request. The following applies for pumps without follower plate: The maximum filling (MAX marking) must be reduced according to the expected inclination (e.g. In case of construction or agricultural machinery). The minimum filling (MIN marking) must be increased as of an expected inclination of  $> 30^\circ$ , as otherwise a reduced lubricant volume in the suction area of the pump could result in a functional impairment.

## 4.2 Protection types and classes

Degree of protection	IP6K9K
Types of protection	
- Square plug	SELV / PELV / FELV
- Bayonet plug	SELV / PELV
- Screwed cable gland with cable and Deutsch plug	SELV / PELV



The specified degree of protection of the pump assumes that IP6K9K-capable connection sockets and corresponding cables are used. When using connection sockets and cables with a lower degree of protection, classification is made according to the lowest degree of protection. For the achievable degrees of protection when using the connection sockets and cables supplied by us, see chapter Spare parts.

## 4.3 Hydraulic connection diagram

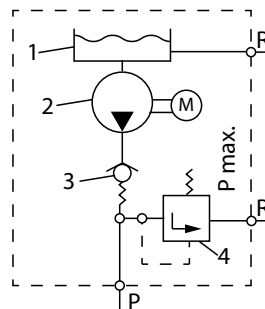

- 1 = Reservoir
- 2 = Pump
- 3 = Check valve
- 4 = Pressure control valve
- R = Return line
- P = Pressure line

#### 4.4 Nominal output volumes



The stated nominal outputs per stroke and pump element refer to NLGI 2 lubrication greases at an ambient temperature of + 20 °C [68 °F] and a back pressure of 100 bar [1450 psi] on the pump element. Deviating operating conditions or deviating pump configuration result in a changed motor speed and thus in a change of the output per time unit. If as a consequence of the changed motor speed the output per time unit needs to be adapted, this will be done by adapting the lubrication and pause time settings of the pump.

Pump element	L <sup>3)</sup>	5	6	7	R	B	C <sup>4)</sup>	Unit
Nominal output per stroke	0.03 [0.0018]	0.10 [0,006]	0.16 [0.0097]	0.22 [0.0134]	0.04 - 0.18 [0.0024-0.019]	0.10 [0,006]	0.24 [0.0146]	cc [cu. in.]

##### 4.4.1 Influencing variables on the output volume

Influencing variables	Increasing the output	Reducing the output
Ambient temperature	> + 20 °C [68 °F]	< + 20 °C [68 °F]
Consistency class of the lubrication grease	< NLGI 2	N/A
Number of pump elements	N/A	> 1
Back pressure at the pump element	< 100 bar [1450 psi]	> 100 bar [1450 psi]

<sup>3)</sup> Pump element L may be used for the supply of NLGI 00 lubrication greases only. Observe the limits stated in chapter Limits of use of the intermittent low-level indication.

<sup>4)</sup> Pump element C serves to supply exclusively chisel paste. When using chisel paste, observe the corresponding notes in the chapter Lubricants.

#### 4.4.2 Output diagrams of typical NLGI 2 lubricants

Low temperature lubrication grease

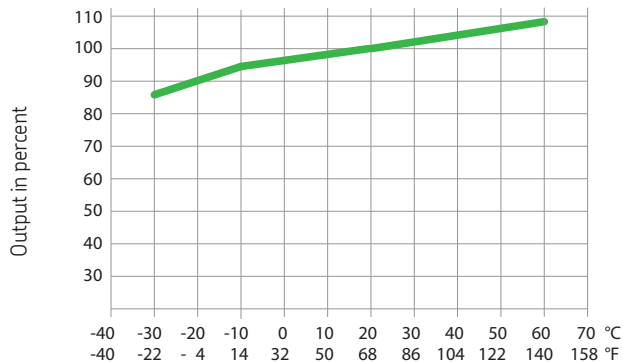

High temperature lubrication grease

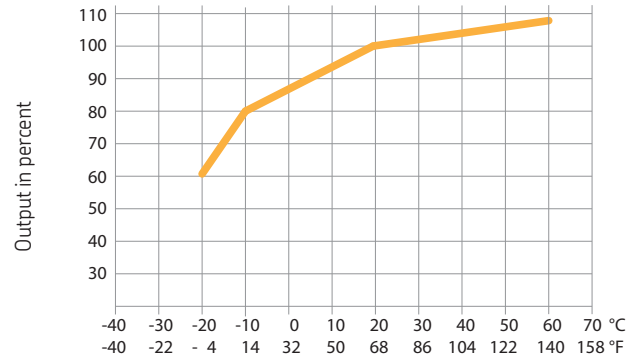

The output diagrams represent the average value of the different high- respectively low-temperature lubrication greases.

Calculation of the output using the example of a high-temperature lubrication grease

Nominal speed of the pump motor per minute x nominal output of pump element 7 per stroke x efficiency in percent at an assumed ambient temperature of -10 °C [14 °F] = 20 rpm x 0.22 cc (0.0134) x 80 % = 3.5 cc/min [0.214 cu.in./min.].



#### 4.5 Functioning principle of the intermittent low-level indication

The intermittent low-level indication operates free of contact. Its main components are the following:

- o firmly positioned magnetic switch (I) inside of the reservoir bottom
- o flexible guide plate (II) connected to the stirring paddle with a magnet (III) and a control cam (IV)

If the reservoir is filled with a lubrication grease suitable for the intermittent low-level indication and the pump is operating, then the guide plate (II) is deflected by the resistance of the lubrication grease. As a consequence the magnet (III) connected to the guide plate (II) is moved on its inner circuit and cannot trigger a pulse at the magnetic switch (I) with its magnetic field. A control cam (IV) positively guides the magnet together with the pivoted guide plate towards the outside during each revolution. As soon as the guide plate leaves the control cam, the lubricant's resistance pushes the guide plate together with the magnet to the inside again.

As soon as the lubricant inside the reservoir has fallen to that level that the lubricant's resistance is no more sufficient to further deflect the guide plate (II), the magnet (III) remains on the outer circuit and triggers a pulse each time it slides across the magnetic switch (I). If during an operating cycle the magnet (III) slides across the magnetic switch (I) six times, a low-level signal is sent by the control printed circuit board of the pump. For programming of the external control of the pump, see corresponding chapter in these instructions.

Perspective representation

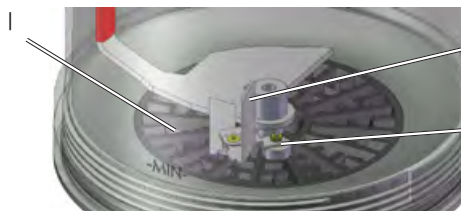

Schematic representation

Magnet on inner circuit

Magnet on outer circuit

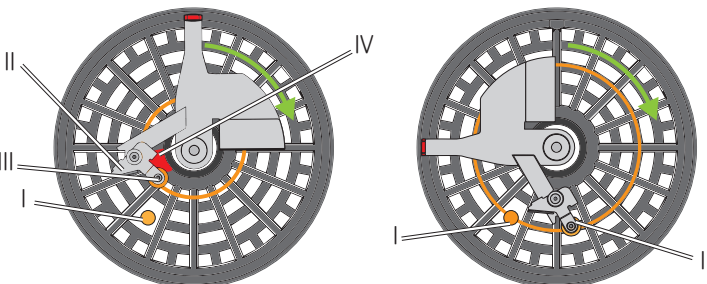

#### 4.6 Limits of use of the intermittent low-level indication

The following lubricant consistencies have to be complied with in order to ensure the correct functioning of the intermittent low-level indication. Above the stated range of temperature a correct functioning of the intermittent low-level indication cannot be ensured. The inferior temperature ranges require the suitability of the lubricant for the respective temperature range. Otherwise the too high consistency of the lubricant may result in malfunctions, e.g. interruption of the lubricant supply, or in damages to the pump (e. g. bending of the stirring paddle).



The intermittent low-level indication is not appropriate for lubricants of NLGI class  $\leq 0$ .

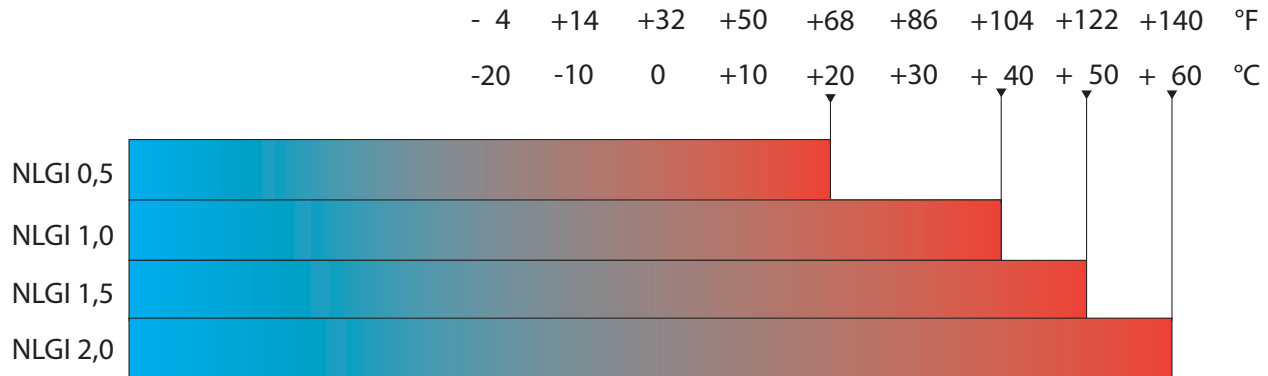

#### 4.7 Processing of the low-level signals in case of external controller and monitoring of the pump

The following statements apply to pumps with control printed circuit board type V and for pumps without printed circuit board with external controller and monitoring.

To avoid early low-level indication (e.g. caused by air inclusions or wave formation in the lubricant) in case of external controller or monitoring the following conditions have to be fulfilled by programming the external controller accordingly.

- After each operating cycle the pulses of the intermittent low-level indications have to be deleted.



Pulses must never be added up over several operating cycles. This will result in an early low-level indication.

##### Operating cycle $\geq 32$ seconds:

- Each operating cycle requires at least 6 signals by the magnetic switch .

##### Operating cycle $\geq 24$ seconds $\leq 32$ seconds:

- Each operating cycle requires at least 4 signals by the magnetic switch.

##### Operating cycle $\leq 24$ seconds:

- The number of required magnetic switch signals has to be adapted to the operating conditions to be expected. To do so, contact our Customer Service.

#### 4.7.1 Visualization of a low-level indication

The low-level signal is visualized via an external control light as shown in the connection diagram.

#### 4.7.2 Remaining run time of pump in case of a low-level indication

##### Pumps with internal controller

After a low-level signal the maximum run time is 4 minutes. When the time has lapsed, the internal controller stops the pump until the low-level signal turns off due to filling the reservoir and triggering an additional lubrication.

##### Pump with external controller

The owner has to ensure that the pump is stopped by the external control unit latest 4 minutes after the low-level signal.

#### 4.8 Reservoir versions

In the following you find the possible reservoir variants of the pumps described in these instructions (also see type identification code). For a better representation only the smallest possible reservoir size will be depicted always. In the figures the different reservoir variants may not always be distinguishable visually, as the differences are located in the interior construction (e.g. with and without low level indication). (✓ = available reservoir sizes)

XNFL					
Liter	2*	4	8	11	15
gal.	0.53	1.06	2.11	2.9	3.96
	✓				

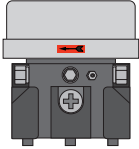

XN / XL / XC				
2	4*	8*	11*	15*
0.53	1.06	2.11	2.9	3.96
✓	✓	✓		✓

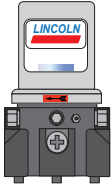

XNBO / XLBO / XCBO				
2	4*	8*	11*	15*
0.53	1.06	2.11	2.9	3.96
✓	✓	✓	✓	✓

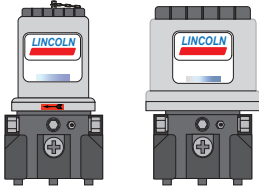

XNBA / XLBA / YLBA / YNBA / XCBA				
2	4*	8*	11*	15*
0.53	1.06	2.11	2.9	3.96
	✓	✓		



XBF / XPF					
Liter	2	4*	8*	11*	15*
gal.	0.53	1.06	2.11	2.9	3.96
		✓	✓	✓	✓



YNBO / YLBO				
2	4*	8*	11*	15*
0.53	1.06	2.11	2.9	3.96
✓	✓	✓		✓

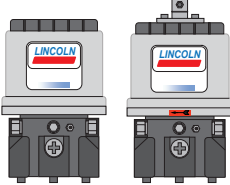

\* These reservoir sizes require an adapter 226-14105-5, if a pressure control valve shall be mounted into the pump element.

#### 4.9 Useable reservoir volume



Regarding the reservoir version without follower plate the useable reservoir volume mainly depends on the NLGI consistency class of the lubricant used and of the ambient temperature. In case of high consistency and low operating temperature normally more lubricant sticks to the inner surfaces of the reservoir and the pump and is thus no more available for being dispensed.

Useable reservoir volume (reservoir without follower plate)	Litres [gal.]	2 [0.53]	4 [1.06]	8 [2.11]	11 [2.90]	15 [3.96]
Lubricants with relatively low consistency <sup>5), 7)</sup>	Litres [gal.]	1.6 - 2.0 [0.42 - 0.53]	3.65 - 4.15 [0.96 - 1.10]	6.65 - 7.15 [1.76 - 1.88]	8.78 - 9.28 [2.32 - 2.45]	14.35 - 14.90 [3.79 - 3.93]
Lubricants with relatively high consistency <sup>6)</sup>	Litres [gal.]	1.8 - 2.0 [0.47 - 0.53]	3.35 - 3.85 [0.88 - 1.01]	7.00 - 7.50 [1.84 - 1.98]	9.13 - 9.63 [2.41 - 2.54]	14.75 - 15.25 [3.90 - 4.03]

<sup>5)</sup> Lubricant consistencies of NLGI -000 lubricants at + 60 °C [140 °F] up to lubricant consistencies of NLGI -1.5 lubricants at + 20 °C [68 °F].

<sup>6)</sup> Lubricant consistencies of NLGI -2 lubricants at + 20 °C [68 °F] up to the maximum admissible lubricant consistency.

<sup>7)</sup> When using lubricants of a relatively low consistency in pumps subjected to strong vibrations or tilting motions (e.g. construction and agricultural machinery), make sure to maintain a level that is about 15 mm [0.59 in.] below the MAX marking of the reservoir. This prevents lubricant from entering the reservoir vent. In case of very strong vibrations or large tilting motions this value must be increased, for low vibrations it can be reduced. Changing the filling level by 10 mm [0.4 in.] corresponds to a volume change of about 0.34 litres [0.09 gal.].

#### 4.10 Lubricant requirement for priming of an empty pump

To prime an empty pump up to the MAX marking of the reservoir, the following lubricant quantities are required.

Nominal volume   Litres / [gal.]		2 [0.53]	4 [1.06]	8 [2.11]	11 [2.90]	15 [3.96]
required lubricant quantity	Litres	$3.8 \pm 0.25$	$5.8 \pm 0.25$	$9.15 \pm 0.25$	$12.1 \pm 0.25$	$17.5 \pm 0.25$
	[gal.]	$[1 \pm 0.07]$	$[1.53 \pm 0.07]$	$[2.41 \pm 0.07]$	$[3.20 \pm 0.07]$	$[4.62 \pm 0.07]$



The deviation between the lubricant quantity required for priming and the nominal volume of the reservoir results from the filling of the pump housing up to the MIN marking of the reservoir.

## 4.11 Tightening torques

A	Pump element	20 Nm ± 2,0 Nm	[14.75 ft.lb. ± 1.4 ft.lb.]
B	Pressure control valve	6 Nm -0,5 Nm	[4.43 ft.lb. - 0.07 ft.lb.]
C	Pump	18 Nm ± 1.0 Nm	[13.27 ft.lb. ± 0.74 ft.lb.]
D	Screw cap	2 Nm ± 0.2 Nm	[1.48 ft.lb. ± 0.15 ft.lb.]
E	Housing cover (bottom side)	0.75 Nm ± 0.1 Nm	[0.55 ft.lb. ± 0.07 ft.lb.]
F	Optional filling connection	20 Nm + 2.0 Nm	[14.75 ft.lb. ± 1.4 ft.lb.]
G	Cap screw/ adapter with hydraulic lubrication fitting	10 Nm + 1.0 Nm	[7.38 ft.lb. ± 0.7 ft.lb.]

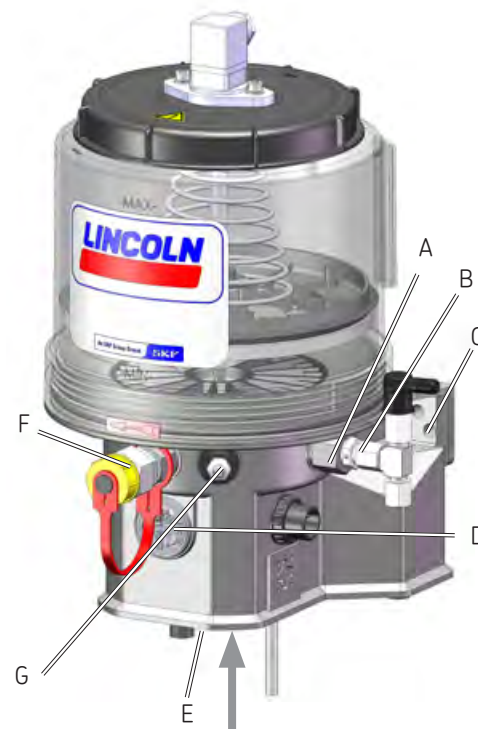

#### 4.12 Factory settings of the lubrication and pause times of pumps with control PCB V10-V23

PCB	Pause time/ lubrication time	Time value	Rotary switch	Position	PCB	Pause time/ lubrication time	Time value	Rotary switch	Position
V10/V20	Pause time	6 hrs	blue	6	V12/V22	Pause time	24 min	blue	6
	Lubrication time	6 min	red	3		Lubrication time	6 min	red	3
V11/V21	Pause time	6 hrs	blue	6	V13/V23	Pause time	24 min	blue	6
	Lubrication time	24 s	red	3		Lubrication time	24 s	red	3

#### 4.13 Possible settings of the lubrication and pause times of pumps with control PCB V10-V23

Position of the rotary switch (blue)	1	2	3	4	5	6	7	8	9	A	B	C	D	E	F
Pause time in minutes <sup>8)</sup>	4	8	12	16	20	24	28	32	36	40	44	48	52	56	60
Pause time in hours <sup>8)</sup>	1	2	3	4	5	6	7	8	9	10	11	12	13	14	15

Position of the rotary switch (red)	1	2	3	4	5	6	7	8	9	A	B	C	D	E	F
Lubrication time in seconds <sup>8)</sup>	8	16	24	32	40	48	56	64	72	80	88	96	104	112	120
Lubrication time in minutes <sup>8)</sup>	2	4	6	8	10	12	14	16	18	20	22	24	26	28	30

<sup>8)</sup> Time values for pause and lubrication times are factory-set via the rotary switches and jumpers on the control PCB. The positions of the jumpers must not be changed by the owner.



#### Note regarding position "0" of the rotary switches

Never turn the rotary switches into position "0". This position is intended exclusively for the owner's purposes. In the "0" position the pump operates with the factory settings and a fault is indicated by the control PCB's right LED.



#### 4.14 Type identification code

The type identification code facilitates selection/ identification of important features of the product. For the type identification code of the respective product, see the type identification plate on the pump.

P	2	0	3	X	D	-	1	1	X	L	B	0	-	6	0	0	-	2	4	-	C	A	0	0	0	0	0	0	-	V	1	3	A	+	A	D	R	Example
	A			B	C		D			E				F				G			H	K	H	K	H	K	H	K		L	M			N			Category	
															1	2	3					X1	X2	X3	X4												Position	

<b>A   Product designation<sup>9)</sup></b>	
P203	
<b>B   Corrosion protection classes<sup>9)</sup></b>	
_ = C3	Term of protection ≥ 15 years <sup>10)</sup>
X = C5-M	Term of protection ≥ 15 years <sup>10)</sup>
<b>C   Approvals<sup>9)</sup></b>	
E = E1 (ECE R10)	
D = E1 + UL	
<b>D   Reservoir sizes<sup>9)</sup></b>	
2 = 2 l	[0.53 gal.]
4 = 4 l	[1.06 gal.]
8 = 8 l	[2.11 gal.]
11 = 11 l	[2.90 gal.]
15 = 15 l	[3.96 gal.]

<sup>9)</sup> From these categories only one feature can be selected at a time.

<sup>10)</sup> The duration of the corrosion protection does not stand for the warranty period

C5-M versions cannot be combined with pump elements L, R, B and C.

<sup>11)</sup> Reservoirs for lubrication oil cannot be combined with features L, B and C from category (F), nor with features A and S from category (M).

<b>E   Reservoir versions<sup>9)</sup></b>	
XN	= Lubrication grease without low-level indication
XL	= Lubrication grease with intermittent low-level indication (NO)
XC	= Lubrication grease with intermittent low-level indication (NC)
XNFL	= Lubrication grease without low-level indication (flat reservoir)
XNBO	= Lubrication grease without low-level indication with reservoir lid
XLBO	= Lubrication grease with intermittent low-level indication (NO) and reservoir lid
XNBA	= Lubrication grease without low-level indication with lockable reservoir lid
XLBA	= Lubrication grease with intermittent low-level indication (NO) and lockable reservoir lid
XBF	= Lubrication grease with follower plate, high- and low-level indication
XPF	= Lubrication grease with follower plate, high- and low-level indication and pre-warning
XCBO	= Lubrication grease with intermittent low-level indication (NC) and reservoir lid
XCBA	= Lubrication grease with intermittent low-level indication (NC) and lockable reservoir lid
YNBO <sup>11)</sup>	= Lubrication oil without low-level indication with reservoir lid
YLB0 <sup>11)</sup>	= Lubrication oil with float magnetic switch, low-level indication and reservoir lid
YNBA <sup>11)</sup>	= Lubrication oil without low-level indication with lockable reservoir lid
YLBA <sup>11)</sup>	= Lubrication oil with float magnetic switch, low-level indication and lockable reservoir lid

P	2	0	3	X	D	-	1	1	X	L	B	0	-	6	0	0	-	2	4	-	C	A	0	0	0	0	0	0	-	V	1	3	A	+	A	D	R	Example
	A		B	C			D			E				F				G			H	K	H	K	H	K	H	K			L	M			N			Category
														1	2	3					X1	X2	X3	X4														Position

#### F | Pump elements<sup>12)</sup>

0	=	without pump element	
L	=	Piston Ø 5 mm [0.20 in.]	Output volume of pump elements, see chapter Nominal output volume
5	=	Piston Ø 5 mm [0.20 in.]	
6	=	Piston Ø 6 mm [0.23 in.]	
7	=	Piston Ø 7 mm [0.28 in.]	
R	=	Piston Ø 7 mm [0.28 in.]	adjustable output
B	=	Piston Ø 7 mm [0.28 in.]	with bypass
C	=	Piston Ø 7 mm [0.28 in.]	for chisel paste
Thread: Connection M22x1.5 Outlet G1/4			

#### G | Rated voltage<sup>9)</sup>

12	=	12 V DC
24	=	24 V DC

Positions of the pump elements in the type identification code



If only 2 pump elements are required, these should be positioned oppositely to one another (positions 1 and 3).

<sup>12)</sup> From these categories there is always required a multiple selection with indication of the position.

P	2	0	3	X	D	-	1	1	X	L	B	0	-	6	0	0	-	2	4	-	C	A	0	0	0	0	0	0	-	V	1	3	A	+	A	D	R	Example
A				B C		D		E				F				G				H K H K H K H K				L M				N				Category						
												1	2	3	X1				X2	X3	X4					Position												

<b>H   Connections types on the pump<sup>12)</sup></b>	
O	= No connection to the pump
A	= Square plug V10-V13 PCB (special assignment)
C	= Square plug V10-V13 PCB
E	= Square plug V20-V23 PCB
5	= Bayonet plug 4/3 poles <sup>13)</sup>
R	= Bayonet plug 7/6 poles <sup>13)</sup>
8	= Screwed cable gland with cable and Deutsch plug
F	= Square plug - control PCB / signal

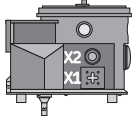
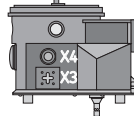
<b>Possible positions of the connection types on the pump</b>					
Left side:	Right side:	X1	X2	X3	X4
		A	0	0	0
		A	0	F	0
		C	0	0	0
		C	0	F	0
		E	0	0	0
Example out of the above type identification code: X1 is the position of the square plug (C). X2-X4 are not assigned.		E	0	F	0
		O	5	0	0
		O	R	0	0
		O	8	0	0

<b>K   connection material<sup>12)</sup> <sup>13)</sup></b>	
O	= Without connection material
1	= Only connection socket (black)
A	= Connection socket (black) with moulded cable 10 m [33 ft]
C	= Connection socket (black) with fitted ADR cable 10 m [33 ft]
E	= Bayonet socket 4/3-wire LLC with cable 10 m [33 ft]
G	= Bayonet socket 7/6-wire LLC +LDT with cable 10 m [33 ft]
2	= Only connection socket (grey)
B	= Connection socket (grey) with moulded cable 10 m [33 ft]
D	= Connection socket (grey) with fitted ADR cable 10 m [33 ft]
L	= Connection socket (grey) with moulded cable 6 m [20 ft]
M	= Bayonet socket 7/3-wire with cable 6 m [20 ft]

<b>Connection material suitable for connection type</b>				
O	A	C	E	
O	A	C	E	Connection material is delivered loosely together with the pump
O	A	C	E	
5				
R				
F				
F				

<sup>12)</sup> From these categories there is always required a multiple selection with indication of the position.

<sup>13)</sup> Always select suitable connection material with bayonet socket for connection types 5 and R

P	2	0	3	X	D	-	1	1	X	L	B	0	-	6	0	0	-	2	4	-	C	A	0	0	0	0	0	0	-	V	1	3	A	+	A	D	R	Example
A				B C		D			E			F			G			H K		H K		H K		H K		L M			N			Category						
													1	2	3					X1	X2	X3	X4					Position										

#### L | Control PCB and factory setting<sup>9)</sup>

V10	=	Terminals 15/30 bridged; pause time = 6 h   lubrication time = 6 min
V11	=	Terminals 15/30 bridged; pause time = 6 h   lubrication time = 24 sec
V12	=	Terminals 15/30 bridged; pause time = 24 min   lubrication time = 6 min
V13	=	Terminals 15/30 bridged; pause time = 24 min   lubrication time = 24 sec
V20	=	Pause time = 6 h   lubrication time = 6 min
V21	=	Pause time = 6 h   lubrication time = 24 sec
V22	=	Pause time = 24 min   lubrication time = 24 sec
V23	=	Pause time = 24 min   lubrication time = 24 sec

#### M | Lubrication grease<sup>9)</sup>

A <sup>14)</sup>	=	Pump factory-filled with Fuchs Renocal FN 745
S <sup>15)</sup>	=	Pump factory-filled with lubricant as specified by customer
Z	=	w/o lubrication grease

#### N | additional indications<sup>9)</sup>

ADR <sup>16)</sup>	=	Pump for hazardous material transporters
A	=	Adapter with lubrication fitting and NPT thread
A+SV	=	Pressure control valve including adapter with 1/8" NPT thread

Observe the note regarding "Terminals 15/30 bridged" in chapter "Changing the lubrication and pause times via jumper setting".

<sup>14)</sup> Pumps are filled with the following grease quantities. Pump without follower plate; 2L reservoir approx. 750 g [27 fl.oz.] ≥ 4L reservoir approx. 1500 g [54 fl.oz.]; pump with follower plate: approx. 2250 g [81 fl.oz.].

<sup>15)</sup> Observe the restrictions regarding CLP / GHS in chapter Safety instructions as well as the lubricant specifications indicated in chapter Technical Data.

<sup>16)</sup> Always select the additional indication ADR together with characteristics C and D from category (K).

## 5. Delivery, returns, and storage

### 5.1 Delivery

After receipt of the shipment, check the shipment for damage and completeness according to the shipping documents. Immediately report any transport damages to the forwarding agent.

Keep the packaging material until any discrepancies are resolved. During in-house transport ensure safe handling.

### 5.2 Returns

Clean all parts and pack them properly (i.e. following the regulations of the recipient country) before returning them.

Protect the product against mechanical influences such as impacts. There are no restrictions for land, sea or air transport.

Mark returns on the packaging as follows.



### 5.3 Storage

SKF products are subject to the following storage conditions:

- dry, dust- and vibration-free in closed premises
- no corrosive, aggressive materials at the place of storage (e. g. UV rays, ozone)
- protected against pests and animals (insects, rodents, etc.)
- possibly in the original product packaging
- shielded from nearby sources of heat and coldness
- in case of high temperature fluctuations or high humidity take adequate measures (e. g. heater) to prevent the formation of condensation water



Before application inspect the products with regard to possible damages occurred during their storage. This particularly applies for parts made out of plastic (embrittlement).

### 5.4 Storage temperature range

- In case of parts not filled with lubricant the admissible storage temperature corresponds to that of the admissible ambient temperature of the pump (see Technical data)
- In case of parts filled with lubricant the admissible storage temperature range is:

min. + 5 °C [+41 °F]

max. + 35 °C [+95 °F]



If the storage temperature range is not adhered to, the following work steps for replacing the lubricant may not in all cases lead to the desired result.

## 5.5 Storage conditions for parts filled with lubricant

The conditions mentioned in the following will have to be adhered to when storing products filled with lubricant,

### 5.5.1 Storage period of up to 6 months

The filled products can be used without having to take further measures.

### 5.5.2 Storage period from 6 to 18 months

#### Pump

- Connect the pump electrically
- Switch the pump on and let it run, e.g. by triggering an additional lubrication, until about 4 cc of lubricant will leak from each pump element
- Switch the pump off and disconnect it from the electrical grid
- Remove and dispose of leaked lubricant

#### Metering devices

- Remove all connection lines and closure screws, if any
- Connect the pump primed with new lubrication grease suitable for the application purpose to the divider bar in such way that the opposite port of the divider bar remains open
- Let the pump run until new lubricant leaks from the divider bar
- Remove leaked lubricant
- Reinstall closure screws and connection lines

#### Lines

- Dismantle preassembled lines
- Ensure that both line ends remain open
- Prime lines with new lubricant

### 5.5.3 Storage period exceeding 18 months

To avoid dysfunctions consult the manufacturer before commissioning. The general procedure to remove the old grease filling corresponds to that of a storage period from 6 to 18 months.

## 6. Installation

### 6.1 General information

Only qualified technical personnel may install the products described in these Instructions.

During assembly pay attention to the following:

- Other units must not be damaged by the assembly
  - The product must not be installed within the range of moving parts
  - The product must be installed at an adequate distance from sources of heat and coldness
  - Observe the product's IP degree of protection
  - Adhere to safety distances and legal prescriptions on assembly and prevention of accidents
- Possibly existing visual monitoring devices, e.g. pressure gauges, MIN/MAX markings or piston detectors, must be clearly visible
  - Observe prescriptions in chapter Technical data regarding the installation position

### 6.2 Place of installation

Protect the product against humidity, dust and vibrations and install it in an easily accessible position to facilitate other installation and maintenance works.

## 6.3 Mechanical connection

### 6.3.1 Minimum assembly dimensions

Ensure sufficient space for maintenance work or for attachment of further components to build a centralized lubrication system to the pump by leaving a free space of at least 100 mm [3.94 in.] into each direction in addition to the stated dimensions.

Reservoir version	Reservoir size ~ Height (H) mm [in.]					Reservoir size ~ Width (B) mm [in.]					Reservoir size ~ Depth (T) mm [in.]				
	2	4	8	11	15	2	4	8	11	15	2	4	8	11	15
Litres	2	4	8	11	15	2	4	8	11	15	2	4	8	11	15
gal.	[0.53]	[1.06]	[2.11]	[2.90]	[3.96]	[0.53]	[1.06]	[2.11]	[2.90]	[3.96]	[0.53]	[1.06]	[2.11]	[2.90]	[3.96]
XN	325	355	458	<del>708</del>	<del>708</del>	213	230	250	<del>240</del>	<del>240</del>	224	250	250	<del>244</del>	<del>244</del>
	[12.79]	[13.98]	[18.03]	<del>[27.87]</del>	<del>[27.87]</del>	[8.39]	[9.06]	[9.84]	<del>[9.45]</del>	<del>[9.45]</del>	[8.81]	[9.84]	[9.84]	<del>[9.60]</del>	<del>[9.60]</del>
XNFL	244	<del>244</del>	<del>244</del>	<del>244</del>	<del>244</del>	232	<del>232</del>	<del>232</del>	<del>232</del>	<del>232</del>	250	<del>250</del>	<del>250</del>	<del>250</del>	<del>250</del>
	[9.61]	<del>[9.61]</del>	<del>[9.61]</del>	<del>[9.61]</del>	<del>[9.61]</del>	[9.13]	<del>[9.13]</del>	<del>[9.13]</del>	<del>[9.13]</del>	<del>[9.13]</del>	[9.84]	<del>[9.84]</del>	<del>[9.84]</del>	<del>[9.84]</del>	<del>[9.84]</del>
XNBO	360	350	457	611	729	211	232	232	227	216	224	250	250	224	244
	[14.17]	[13.78]	[18]	[24.06]	[28.7]	[8.30]	[9.13]	[9.13]	[8.93]	[8.50]	[8.82]	[9.84]	[9.84]	[8.82]	[9.61]
XNBA	<del>360</del>	360	467	<del>467</del>	<del>467</del>	<del>250</del>	250	230	<del>230</del>	<del>230</del>	<del>250</del>	250	251	<del>251</del>	<del>251</del>
	<del>[14.17]</del>	[14.17]	[18.36]	<del>[18.36]</del>	<del>[18.36]</del>	<del>[9.84]</del>	[9.84]	[9.06]	<del>[9.06]</del>	<del>[9.06]</del>	<del>[9.84]</del>	[9.84]	[9.88]	<del>[9.88]</del>	<del>[9.88]</del>
XL	330	355	465	<del>465</del>	<del>465</del>	213	230	230	<del>230</del>	<del>230</del>	224	250	250	<del>250</del>	<del>250</del>
	[13]	[13.98]	[18.30]	<del>[18.30]</del>	<del>[18.30]</del>	[8.30]	[9.06]	[9.06]	<del>[9.06]</del>	<del>[9.06]</del>	[8.82]	[9.84]	[9.84]	<del>[9.84]</del>	<del>[9.84]</del>
XLBO	360	355	457	618	730	213	250	230	220	220	224	250	251	250	244
	[14.17]	[13.98]	[17.99]	[24.33]	[28.74]	[8.30]	[9.84]	[9.06]	[8.66]	[8.66]	[8.82]	[9.84]	[9.88]	[9.84]	[9.61]
XLBA	<del>365</del>	365	467	<del>467</del>	<del>467</del>	<del>250</del>	250	230	<del>230</del>	<del>230</del>	<del>250</del>	250	251	<del>251</del>	<del>251</del>
	<del>[14.37]</del>	[14.37]	[18.39]	<del>[18.39]</del>	<del>[18.39]</del>	<del>[9.84]</del>	[9.84]	[9.06]	<del>[9.06]</del>	<del>[9.06]</del>	<del>[9.84]</del>	[9.84]	[9.88]	<del>[9.88]</del>	<del>[9.88]</del>
XC	325	355	458	<del>729</del>	<del>729</del>	213	230	250	<del>230</del>	<del>230</del>	224	250	250	<del>250</del>	<del>250</del>
	[12.80]	[13.98]	[18.03]	<del>[28.70]</del>	<del>[28.70]</del>	[8.30]	[9.06]	[9.06]	<del>[9.06]</del>	<del>[9.06]</del>	[8.82]	[9.84]	[9.84]	<del>[9.84]</del>	<del>[9.84]</del>



Reservoir version	Reservoir size ~ Height (H) mm [in.]					Reservoir size ~ Width (B) mm [in.]					Reservoir size ~ Depth (T) mm [in.]				
	Litres	2	4	8	11	15	2	4	8	11	15	2	4	8	11
gal.	[0.53]	[1.06]	[2.11]	[2.90]	[3.96]	[0.53]	[1.06]	[2.11]	[2.90]	[3.96]	[0.53]	[1.06]	[2.11]	[2.90]	[3.96]
XCBO	360	380	482	618	730	213	250	230	220	220	224	250	251	250	244
	[14.17]	[14.96]	[18.97]	[24.33]	[28.74]	[8.30]	[9.84]	[9.06]	[8.66]	[8.66]	[8.82]	[9.84]	[9.88]	[9.84]	[9.61]
XCBA		390	492				250	230				250	251		
		[15.35]	[19.37]				[9.84]	[9.06]				[9.84]	[9.88]		
XBF		408	498	611	785		232	251	227	227		250	260	244	244
		[16.06]	[19.61]	[24.06]	[30.91]		[9.13]	[9.88]	[8.94]	[8.93]		[9.84]	[10.24]	[9.61]	[9.61]
XPF		408	498	611	785		408	498	611	785		250	260	244	244
		[16.06]	[19.61]	[24.06]	[30.91]		[16.06]	[19.61]	[24.06]	[30.91]		[9.84]	[10.24]	[9.61]	[9.61]
YNBO	390	350	457		745		232	232		227		250	250		244
	[15.35]	[13.78]	[17.99]		[29.33]		[9.13]	[9.13]		[8.93]		[9.84]	[9.84]		[9.61]
YNBA		360	467				232	232				250	250		
		[14.17]	[18.39]				[9.13]	[9.13]				[9.84]	[9.84]		
YLBO	390	398	510		785		250	250		227		250	250		244
	[15.35]	[15.67]	[20.08]		[30.91]		[9.84]	[9.84]		[8.93]		[9.84]	[9.84]		[9.61]
YLBA		408	500				250	250				250	250		
		[16.06]	[19.69]				[9.84]	[9.84]				[9.84]	[9.84]		

Minimum assembly dimensions Fig. 6

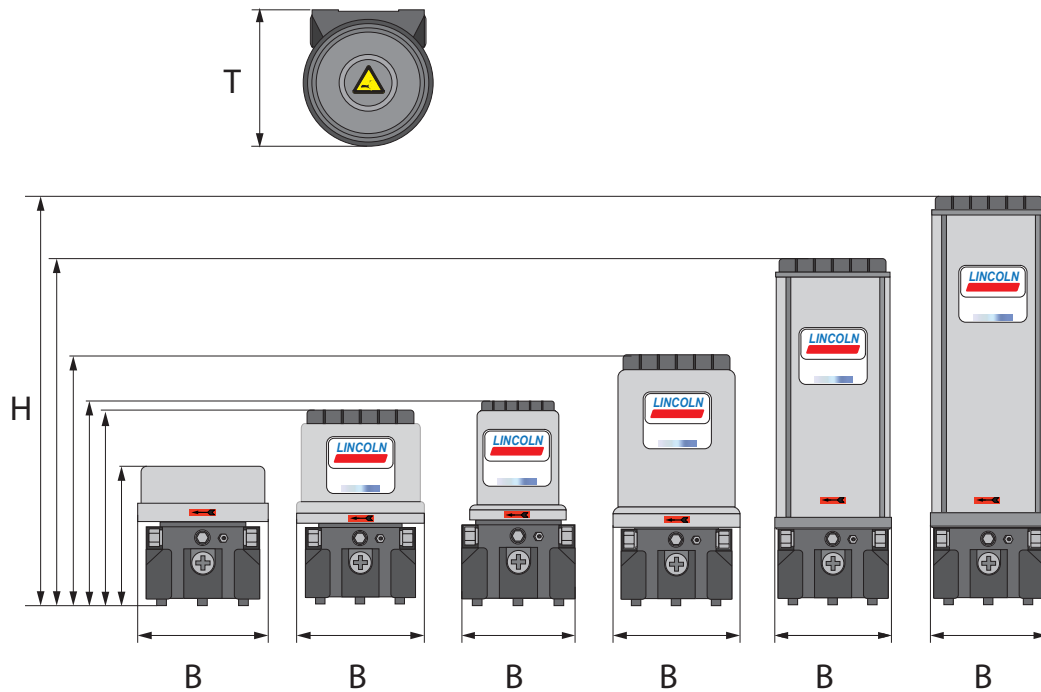

## 6.3.2 Installation bores

**NOTICE****Risk of damage to the superior machine and to the pump**

Drill the mounting bores on non-load-bearing parts of the superior machine only. Fastening must not be done on two parts moving against one another (e. g. machine bed and machine assembly).

When assembling pumps with 11l [2.9 gal.] or 15l [3.96 gal.] reservoirs the flatness of the upper and the lower mounting surfaces may deviate by a maximum of 1 mm [0.039 in.] from each other.

Fastening is done by means of:

2 resp. 3 screws	M8 (8.8)
2 resp. 3 hexagon nuts	M8 (8.8)
2 resp. 3 washers	8

Tightening torque = 18 Nm ± 1.0 Nm  
[13.27 ft.lb. ± 0.74 ft.lb.]

Diameter of bores in the pump housing =  $\varnothing$  9 mm [0.35 in.]

Pumps with 2 l [0.53gal.] or 4 l [1.06 gal.] reservoir

Are fixed at the two lower fastening points (A) or (B) of the pump housing.

A1	=	162 mm	[6.38 in.]
B1	=	180 mm	[7.09 in.]
A2	=	124 mm	[4.88 in.]
B2	=	112 mm	[4.41 in.]

Pumps with 8 l [2.11 gal.] reservoir

Are fixed at the three lower fastening points (A) or (B) and (C) of the pump housing.

C1	=	83 mm	[3.27 in.]
C2	=	95 mm	[3.74 in.]

Fastening points at the P203 pump housing Fig. 7

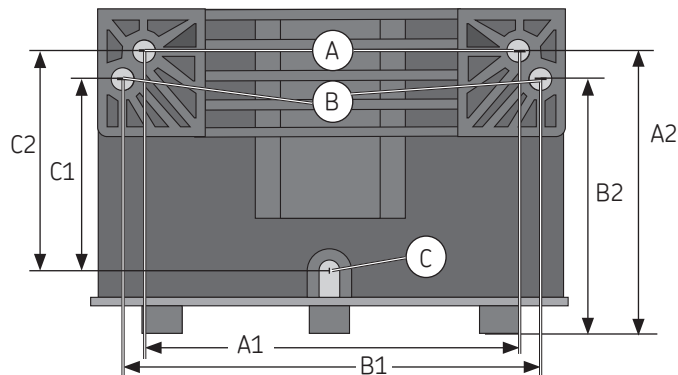

Pumps with 11 l [2.9 gal.] or 15 l [3.96 gal.] reservoir

Are fixed on the lower mounting bores (A) or (B) of the pump housing and additionally on the 2 upper mounting points (D).



Fastening (A) and (B), see previous Figure.

Fastening on top on the fixing angle by means of:

2 screws	M8 (8.8)
2 hexagon nuts	M8 (8.8)
2 washers	8

Tightening torque = 18 Nm ± 1.0 Nm  
[13.27 ft.lb. ± 0.74 ft.lb.]

Diameter of the bores at the upper fixing angle = Ø 10.4 mm [10 in.]

Reservoir 11l [2.90 gal.]

D1 =	557 mm [21.93 in.]
D2 =	160 mm [6.30 in.]
D3 =	80 mm [3.15 in.]

Reservoir 15 l [3.96 gal.]

D1 =	675 mm [26.57 in.]
D2 =	160 mm [6.30 in.]
D3 =	80 mm [3.15 in.]

Mounting bores for pumps with 11 l [2.9 gal.] or 15 l [3.96 gal.] reservoir Fig. 8

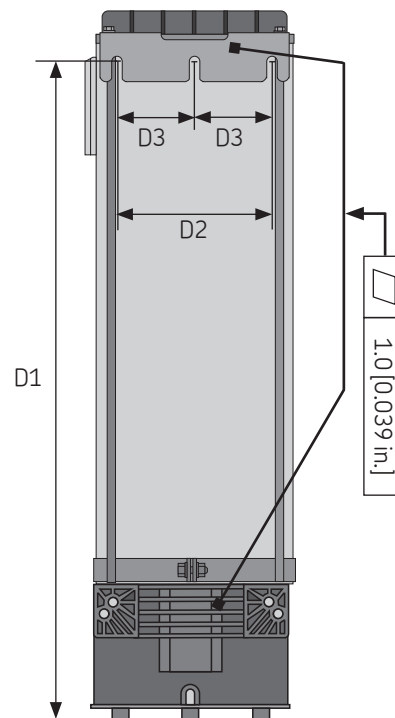

## 6.4 Electrical connection

**WARNING****Electric shock**

Make sure to disconnect the product from the power supply before carrying out any works on electrical components.

Carry out the electrical connection according to the connection type of the pump,

- Tailor the line for the power supply (5.1) according to the respective connection diagram in these instructions or use pre-fabricated cable (see type identification code)
- Insert bushing into corresponding plug and tighten respectively in case of square plugs tighten with its screw. Only be doing so the degree of protection can be complied with



Connect the line in such way that no mechanical forces are transferred to the product.



Electrical connection, Fig. 9

## Types of connections

## Square plug



## Bayonet plug

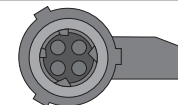

## Screwed cable gland with cable and Deutsch plug

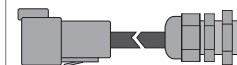

The electrical connection of the low-level indication (5.3) of pumps with follower plate is made according to the pump's connection type. See chapter Connection of the signal line to the reservoir lid

Electrical connection of the low-level indication of pumps with follower plate Fig. 10



### 6.5 Adjusting the output volume on the pump element R



The output of pump element R can be adjusted only while the pump is idle. Factory setting is full supply, i.e. The adjusting measure is  $S = 29 \text{ mm}$  [1.14 in.].

To set the output volume proceed as follows:

- Loosen the counter nut (3.2)
- Adjust the output volume by screwing the spindle (3.3) to the indicated measure according to the table on the right

⌚ = lower output volume

⌚ = higher output volume

- After adjusting the output volume, retighten the counternut (3.2)

Tightening torque =  $20 \text{ Nm} \pm 2.0 \text{ Nm}$   
[14.75 ft.lb.  $\pm$  1.4 ft.lb.]

Adjusting the output volume on pump element R Fig. 11

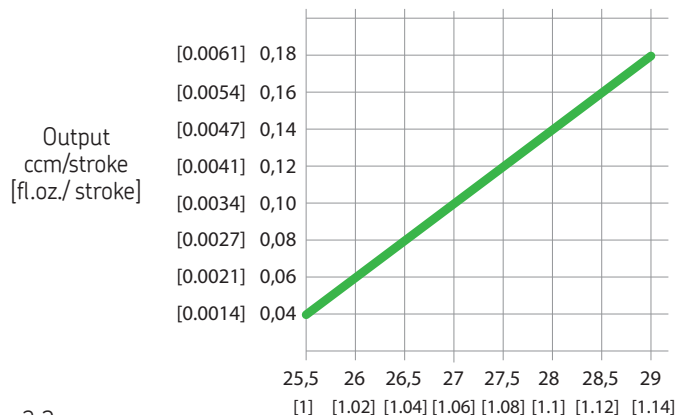

### 6.6 Mount pressure control valve

Protect each pump element by means of a pressure control valve suitable for the planned maximum admissible operating pressure of the centralized lubrication system.



Observe the information given in chapter 4 regarding the adapter required for certain reservoir sizes.

To carry out the assembly proceed as follows:

- Remove the closure plug (3.1) from the pump element (3)
- Screw pressure control valve (8) into pump element (3)
- Repeat procedure for each pump element

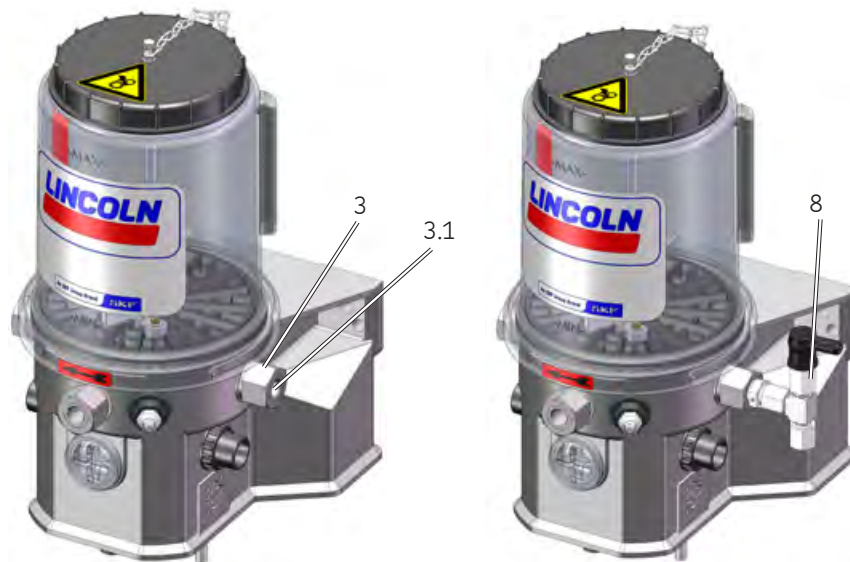

Tightening torque = 6 Nm -0.5 Nm  
[4.43 ft.lb. - 0.07 ft.lb.]

Mounting the pressure control valve Fig. 12





### 6.7 Lubrication line connection

 <b>CAUTION</b>
 <p><b>Risk of falling</b> Exercise care when dealing with lubricants. Bind and remove spilled or leaked lubricants immediately.</p>



Connect lubrication lines in such way that no forces are transferred to the product (tension-free connection).

All components of the centralized lubrication system must be laid out for:

- the maximum arising operating pressure
- the admissible ambient temperature
- the output volume and the lubricant to be supplied

Observe the following installation instructions for safe and smooth operation.

- Use clean components and filled lubrication lines only
- The main lubrication line should be laid preferably rising with a possibility to vent it at its highest point. Lubrication lines shall generally be laid in such way that there can never be created air pockets at any point
- Possibly mount the lubricant metering devices at the end of the main lubrication line in such way that the outlets of the lubricant metering devices show upwards
- If lubricant metering devices have to be mounted below the main lubrication line, then this should not be done at the end of the main lubrication line

- The lubricant flow should not be impeded by the installation of sharp elbows, angle valves, gaskets protruding to the inside, or cross-section changes (big to small). Provide unavoidable changes of the cross sections in the lubrication lines with as smooth transitions as possible

## 6.8 Filling with lubricant

### 6.8.1 Filling via the reservoir lid

#### WARNING



#### Crushing hazard

on the rotating stirring paddle. Filling via the reservoir lid is allowed only after disconnecting the pump from the power supply by removing it from the connection (5.1).

- Unscrew the reservoir lid (1.1) anti-clockwise from the reservoir. Deposit the reservoir lid at a clean place. The inside of the reservoir lid must not be contaminated. Remove possible contaminations
- Fill the reservoir from the top up to the MAX marking. Make sure to fill in the lubricant without air inclusions, if possible
- Reinstall the reservoir lid (1.1) clockwise

Filling via the reservoir lid Fig. 13

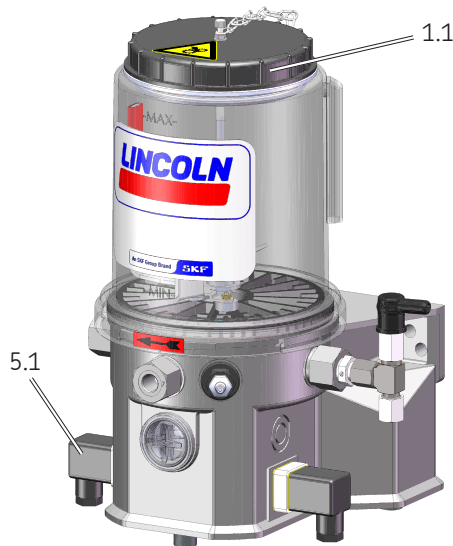

### 6.8.2 Filling via filler fitting

- Connect filling connection of filler pump with filler fitting (4)
- Switch on filler pump and fill reservoir until shortly below the MAX marking
- Switch filler pump off and remove it from filler fitting (4) of pump

Filling via filler fitting Fig. 14

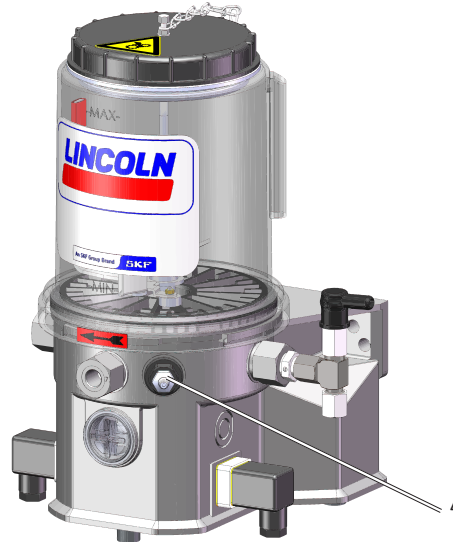

### 6.8.3 Filling via the optional filling connection

- Unscrew protective cap (20.1) from filling connection (20) anticlockwise
- Connect filling connection of filler pump with filler fitting (20)
- Switch on filler pump and fill reservoir until shortly below the MAX marking
- Switch off filler pump and remove it from filler fitting (20) of pump
- Screw protective cap (20.1) clockwise onto filling connection (20) of pump again

Filling via optional filling connection Fig. 15



### 6.9 Setting of lubrication and pause times

Lubrication and pause times are set via the two rotary switches on the control PCB.

- Remove screw cap (9) including sealing ring
- Set the pause time by turning the left blue rotary switch (11.1)
- Set the lubrication time by turning the right red rotary switch (11.2)
- Mount screw cap (9) with gasket again

Tightening torque =  $2 \text{ Nm} \pm 0.2 \text{ Nm}$   
[1.48 ft.lb.  $\pm$  0.15 ft.lb.]



Do not turn the rotary switches in the "0" position. In the "0" position the pump operates with the factory settings and a fault is indicated by the control PCB's right LED.

Setting of lubrication and pause times Fig. 16

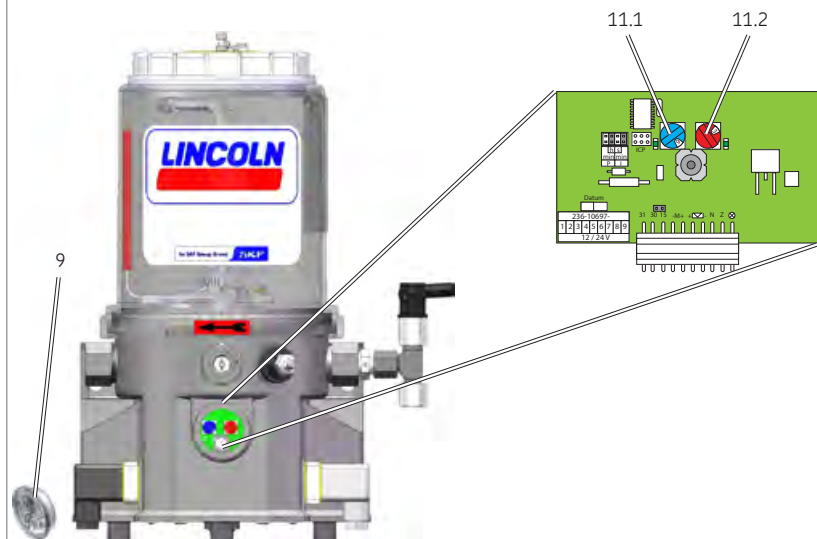









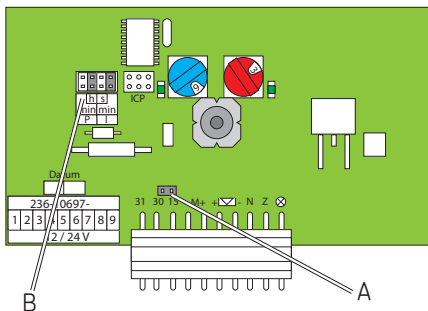





## 6.10 Changing the lubrication and pause times via jumper setting

## NOTICE

**Damage to the superior machine**

Jumper positions on the control PCB should never be changed. Changed jumper positions cannot be easily recognized by other persons and may therefore result in wrong settings of the lubrication and pause times.



Jumper position for bridge Terminals 15/30	Control PCB	Pause time		Lubrication time		Jumper position on the control PCB
		4 - 60 min.	1 - 15 h	8-120 s	2-30 min	
A 	V 10					 B
not bridged	V 20		X		X	 B
A 	V 11					 B
not bridged	V 21		X	X		 B
A 	V 12					 B
not bridged	V 22	X			X	 B
A 	V 13					 B
not bridged	V 23	X		X		 B
	 = Jumper positioned					
* If terminal 15 (machine contact/ drive switch) is bridged with terminal 30 (+) and if voltage is present at terminal 30, then the pump can work without the superior machine/ vehicle having to run. Without bridge the pump works only, if also the superior machine/ vehicle runs.						

## 7. Initial start-up

In order to warrant safety and function, a person assigned by the operator must carry out the following inspections. Immediately eliminate detected deficiencies. Deficiencies may be remedied by an authorized and qualified specialist only.

		Start-up check list	
		YES	NO
<b>7.1 Inspections prior to initial start-up</b>			
Electrical connection carried out correctly.		<input type="checkbox"/>	<input type="checkbox"/>
Mechanical connections carried out correctly		<input type="checkbox"/>	<input type="checkbox"/>
The performance data of the previously indicated connections correspond to the specifications stated in the Technical data		<input type="checkbox"/>	<input type="checkbox"/>
All components, such as lubrication lines and metering devices, have been correctly installed		<input type="checkbox"/>	<input type="checkbox"/>
Product protected with adequate pressure control valve		<input type="checkbox"/>	<input type="checkbox"/>
No visible damage, contamination and corrosion		<input type="checkbox"/>	<input type="checkbox"/>
Any dismantled protection and monitoring equipment has been reassembled and checked for correct function		<input type="checkbox"/>	<input type="checkbox"/>
All warning labels on the product are available and in proper condition		<input type="checkbox"/>	<input type="checkbox"/>
The lubrication and pause times adjusted on the control PCB correspond to the planned lubrication and pause times		<input type="checkbox"/>	<input type="checkbox"/>
<b>7.2 Inspections during initial start-up</b>			
No unusual noises, vibrations, accumulation of moisture, or odours present		<input type="checkbox"/>	<input type="checkbox"/>
No unwanted escape of lubricant (leakages) from connections		<input type="checkbox"/>	<input type="checkbox"/>
Lubricant is supplied free from bubbles		<input type="checkbox"/>	<input type="checkbox"/>
Bearings and friction points are provided with the planned amount of lubricant		<input type="checkbox"/>	<input type="checkbox"/>

### 7.3 Acknowledge receipt of a fault indication

To acknowledge receipt of a fault indication proceed as follows:

- Localize fault via flashing frequency and eliminate it
- Remove screw cap (9) including gasket
- Press pushbutton (11.3) on control PCB (< 1 seconds) to acknowledge receipt of a fault. The right LED (11.5) turns off
- Mount screw cap (9) and sealing ring again

Tightening torque = 2 Nm ± 0.2 Nm  
[1.48 ft.lb. ± 0.15 ft.lb.]



A non-acknowledged fault remains stored even after switching off the machine contact/ drive switch, i.e. when switching the pump on again, the LED (11.5) flashes according to the pending fault.

Acknowledging receipt of a fault indication Fig. 17

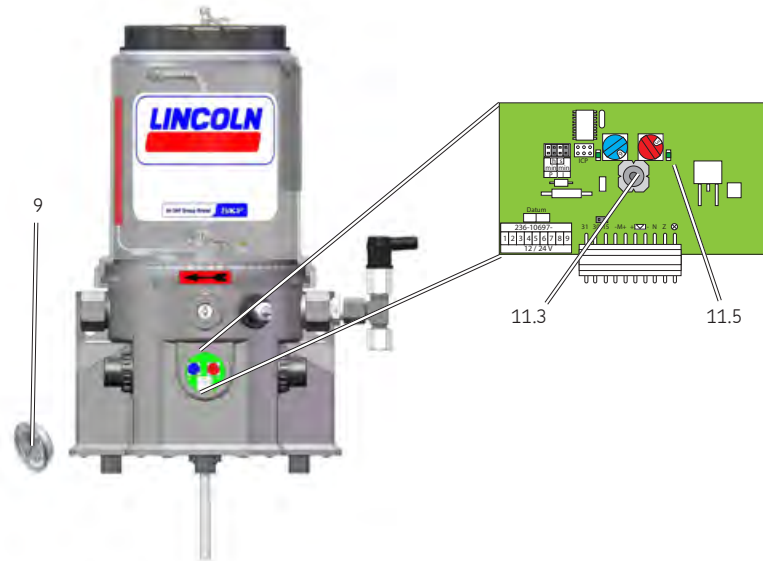



- To start the pump press the pushbutton (11.3) again (> 2 seconds). An additional lubrication will be carried out
- Mount screw cap (9) and gasket again

Tightening torque =  $2 \text{ Nm} \pm 0.2 \text{ Nm}$   
[1.48 ft.lb.  $\pm$  0.15 ft. lb.]

Acknowledging receipt of a fault indication Fig. 18

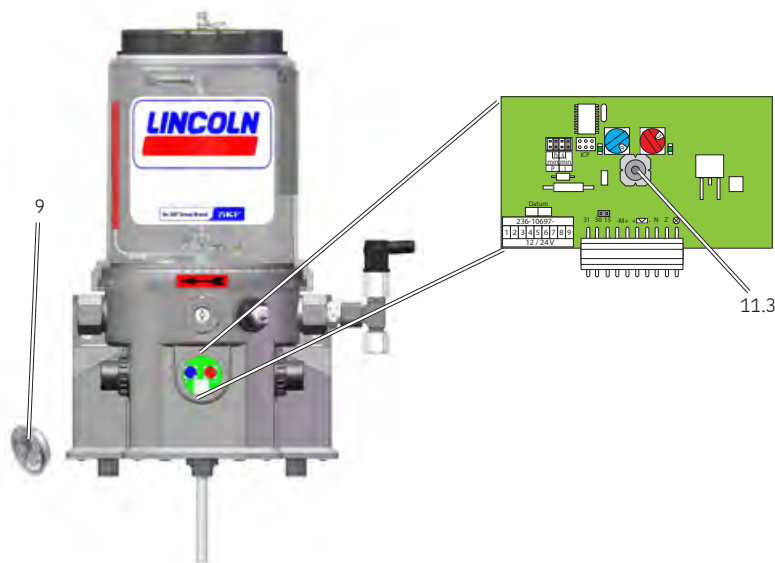

#### 7.4 Triggering an additional lubrication cycle

To trigger an additional lubrication cycle proceed as follows:

- Remove screw cap (9) including sealing ring
- Press the pushbutton (11.3) to trigger an additional lubrication cycle on the control PCB (> 2 seconds). The right LED (11.5) starts lighting and will continue lighting as long as the motor runs

The pump starts a lubrication cycle. The duration of the lubrication cycle corresponds to the value adjusted on the control PCB.

- Mount screw cap (9) and gasket again

Tightening torque =  $2 \text{ Nm} \pm 0.2 \text{ Nm}$   
 $[1.48 \text{ ft.lb.} \pm 0.15 \text{ ft.lb.}]$

Setting of lubrication and pause times Fig. 19

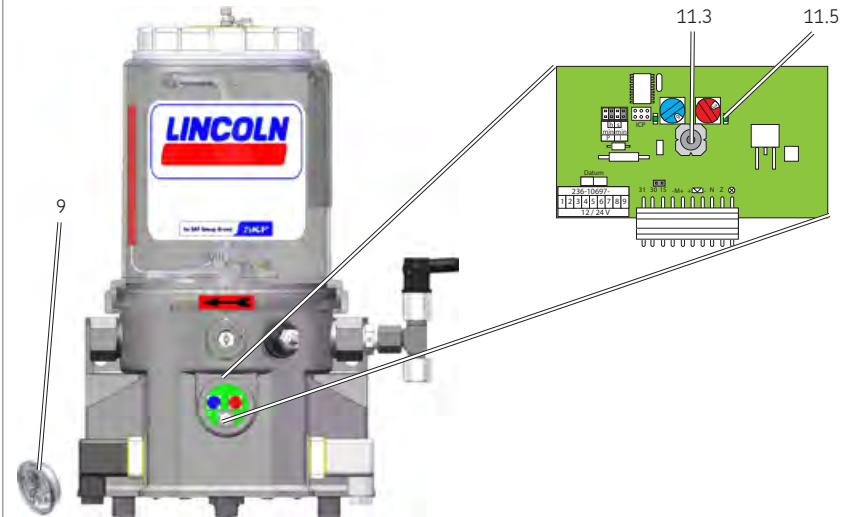

## 8. Operation



SKF products operate automatically to the greatest possible extent.

Basically, activities during standard operation are limited to the control of the filling level of pumps without low-level indication and the timely refilling of lubricant.

### 8.1 Refill lubricant

See chapter Filling with lubricant

## 9. Cleaning

	<b>WARNING</b>
	<p><b>Electric shock</b></p> <p>Carry out cleaning works only on depressurized products that have been disconnected from the power supply. Do not touch cables or electrical components with wet or damp hands.</p> <p>Use steam-jet cleaners or high-pressure cleaners only in accordance with the degree of protection of the pump. Otherwise electrical components may be damaged.</p> <p>Performance of cleaning, required personal protective equipment, cleaning agents and devices following the valid operational regulations of the operator.</p>

### 9.1 Cleaning agents

Cleaning agents compatible with the material may be used only. (Materials, see chapter 2.3).



Thoroughly remove residues of cleaning agents from the product and rinse off with clear water.

### 9.2 Exterior cleaning

- Mark and secure wet areas
- Keep unauthorized persons away
- Thorough cleaning of all outer surfaces with a damp cloth



Make sure to keep the reservoir closed during the cleaning procedure.

### 9.3 Interior cleaning

Normally, interior cleaning is not required. Should incorrect or contaminated lubricant have been filled, inside cleaning of the product will be required. To do so, contact the SKF Customer Service.

## 10. Maintenance

Regular and appropriate maintenance is a prerequisite to detect and clear faults in time. The specific timelines have to be determined, verified at regular intervals and adapted, if necessary, by the operator based on the operating conditions. If needed, copy the table for regular maintenance activities.

Maintenance check list		
Activity to be done	YES	NO
Electrical connection carried out correctly.	<input type="checkbox"/>	<input type="checkbox"/>
Mechanical connections carried out correctly	<input type="checkbox"/>	<input type="checkbox"/>
The performance data of the previously indicated connections correspond to the specifications stated in the Technical data	<input type="checkbox"/>	<input type="checkbox"/>
All components, such as lubrication lines and metering devices, have been correctly installed	<input type="checkbox"/>	<input type="checkbox"/>
Product protected with adequate pressure control valve	<input type="checkbox"/>	<input type="checkbox"/>
No visible damage, contamination and corrosion	<input type="checkbox"/>	<input type="checkbox"/>
Any dismantled protection and monitoring equipment has been reassembled and checked for correct function	<input type="checkbox"/>	<input type="checkbox"/>
All warning labels on the product are available and in proper condition	<input type="checkbox"/>	<input type="checkbox"/>
No unusual noises, vibrations, accumulation of moisture, or odours present	<input type="checkbox"/>	<input type="checkbox"/>
No unwanted escape of lubricant (leakages) from connections	<input type="checkbox"/>	<input type="checkbox"/>
Lubricant is supplied free from bubbles	<input type="checkbox"/>	<input type="checkbox"/>
Bearings and friction points are provided with the planned amount of lubricant	<input type="checkbox"/>	<input type="checkbox"/>

## 11. Troubleshooting

Fault table 1

Fault	Possible cause	Remedy
Pump does not run	Power supply to pump interrupted <ul style="list-style-type: none"> <li>- Superior machine is switched off</li> <li>- Connection cable of pump is loose or defective</li> <li>- External fuse is defective</li> </ul> Pump is in the pause time mode Pump motor is defective Printed circuit board of pump is defective Internal cable break	Check whether one of the indicated faults is present and remedy it in the frame of responsibilities.  Faults outside of your own responsibility have to be reported to your superior to initiate further measures.  If the fault cannot be determined and remedied, please contact our Customer Service.

Fault table 2

Fault	Possible cause	Remedy
Pump runs but supplies no or only little lubricant	Blockade, fault within the centralized lubrication system Defective check valve Defective pressure relief valve Suction bore of pump element is clogged Close pump element Air pockets in the lubricant/ under the follower plate Too high lubricant consistency (at low temperatures) Too low lubricant consistency (at high temperatures) Wrong configuration of metering device within the centralized lubrication system	Check whether one of the indicated faults is present and remedy it in the frame of responsibilities.  Faults outside of your own responsibility have to be reported to your superior to initiate further measures.  If the fault cannot be determined and remedied, please contact our Customer Service.

### 11.1 Display of the operating states and fault conditions by means of the control PCB's LEDs

Particular operating states and fault conditions are displayed via the control PCB's LEDs.

LED display	Possible cause			Remedy
Both LEDs off	A	F	G	Switch on operating voltage; change defective control PCB
Left LED is lit permanently	B			No fault, normal operating state (pause time)
Both LEDs are lit permanently	C			No fault, normal operating state (lubrication time)
Right LED flashes at an interval of four	D			Turn rotary switch out of position "0"
Right LED flashes at an interval of three	E			Replace control PCB



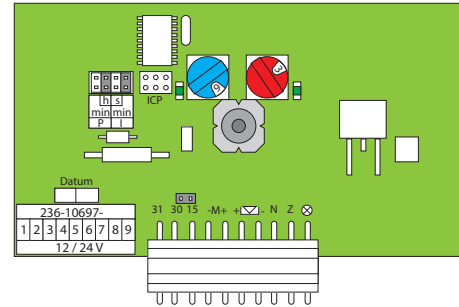

#### Possible cause

- A No (adequate) operating voltage (terminal 15)
- B Operating voltage (terminal 15) is present
- C Motor is running
- D Rotary switch in position "0"
- E Short circuit on pushbutton
- F Control PCB defective
- G Internal cable break





## 12. Repairs

 <b>WARNING</b>
 <b>Risk of injury</b> Before carrying out any repair work, take at least the following safety measures:
 <ul style="list-style-type: none"> <li>○ Keep unauthorized persons away</li> <li>○ Mark and secure work area</li> <li>○ De-pressurize the product</li> <li>○ Disconnect the product from the power supply and secure it against being switched on</li> </ul>
 <ul style="list-style-type: none"> <li>○ Verify that no power is being applied</li> <li>○ Earth and short-circuit the product</li> <li>○ Where needed, cover neighbouring units that are live</li> </ul>

### 12.1 Check pump element and replace pressure control valve.



The characteristics of the new pump element must correspond to the characteristics of the pump element to be replaced.

To replace the pump element, proceed as follows:

- Unscrew defective pump element (3) at its hexagon out of pump housing together with pressure control valve
- Screw the new pump element (3) into the pump housing together with a new gasket

Tightening torque = 20 Nm  $\pm$  2.0 Nm  
[14.75 ft.lb.  $\pm$  1.4 ft.lb.]

- Then screw a new pressure control valve (8) into the pump element

Tightening torque = 6 Nm  $\pm$  0.5 Nm  
[4.43 ft.lb.  $\pm$  0.07 ft.lb.]

Replace pump element Fig. 20



### 12.2 Replacement of the control PCB

The work should possibly be done at room temperature. At low temperatures the replacement may be subject to restrictions. To facilitate replacement of the control PCB the pump should be tilted into horizontal position.

To replace the control PCB proceed as follows:

- Check the new control PCB for accordance with the documentation and the intended purpose
- Take protection measures against electrostatic discharge
- Unscrew the screws (2.2) from the housing cover (2.1)
- Remove housing cover (2.1)
- Remove plug (11.7) from control PCB and pull control PCB (11) out of the two lateral guide rails

Unscrew housing cover Fig. 21

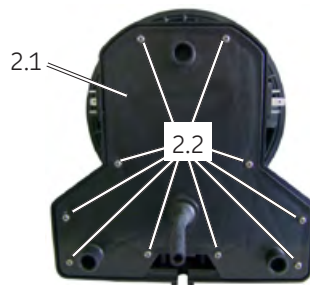

Control PCB removed Fig. 23

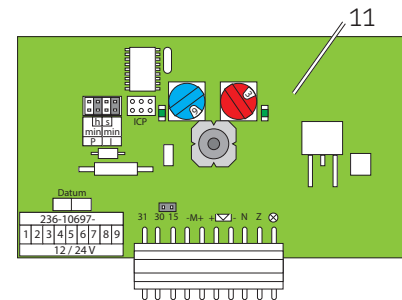

Plug of the control PCB Fig. 22



- Note down any changed jumper positions and rotary switch positions and apply them to the new control PCB
- Place control PCB into lateral guide rails and carefully press it down
- Reinsert plug (11.7)
- Guide the drain hose (12) from rear through the housing cover (2) until it safely engages in the housing cover (2.1) with its notch (12.1)
- Position housing cover (2.1) on pump housing again and retighten with screws (2.2)

Tightening torque =  $0.6 \text{ Nm} \pm 0.1 \text{ Nm}$   
 $[0.44 \text{ ft.lb.} \pm 0.01 \text{ ft.lb.}]$

### 11.3 Installation of the pump at the place of use

Installation and start-up at the place of use shall be carried out as described in chapter Installation.

Mount drain hose Fig. 24

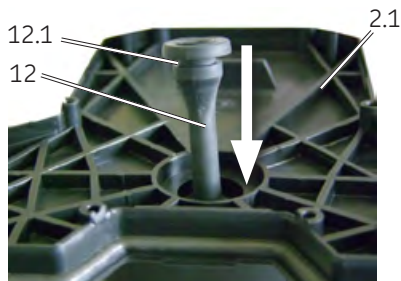

Mount housing cover Fig. 26

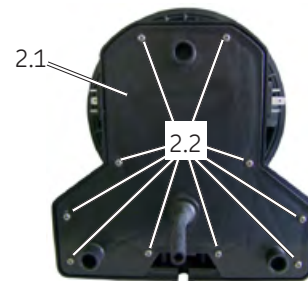

Plug of the control PCB Fig. 25



#### 12.4 Tests after replacement of the control PCB



After replacement of a control PCB carry out an electrical safety test according to ISO 60204-1.

##### Filing

After the replacement of the control PCB the scope and findings of the test have to be recorded in writing and handed over for filing to the person responsible for machine operation.

## 13. Shutdown and disposal

### 13.1 Temporary shutdown

Temporarily shut the system down by:

- Switching off the superior machine
- Disconnecting the product from the power supply

### 13.2 Final shutdown and disassembly

The final shutdown and disassembly of the product must be planned and carried out by the operator in a professional manner and in compliance with all regulations to be observed.

### 13.3 Disposal

#### Countries within the European Union

Disposal should be avoided or minimized wherever possible. Disposal of products contaminated with lubricant must be effected via licensed waste disposal contractor in accordance with environmental requirements and waste disposal regulations as well as local authority requirements.



The specific classification of the waste is in the waste producer's responsibility, as the European Waste Catalogue provides different waste disposal codes for the same type of waste but of different origin.

#### Electrical components

have to be disposed of or recycled following WEEE directive 2012/19/EU.

#### Plastic or metal parts

can be disposed of with the commercial waste.

#### Countries outside the European Union

The disposal has to be done according to the valid national regulations and laws of the country where the product is used.

## 14. Spare parts

The spare parts assemblies may be used exclusively for replacement of identical defective parts. Modifications with spare parts on existing products are not allowed. Exceptions to this are the pump elements and the optional filling connection.

### 14.1 Housing cover Assy.

Designation	Qty.	Part number
Housing cover Assy.	1	544-32217-1

Delivery including drain hose and the corresponding number of screws required for installation

### 14.2 Pump elements

Designation	Qty.	Part number C3 version	Part number C5-M version
Pump element L including gasket	1	600-78018-1	Not available
Pump element 5 including gasket	1	600-26875-2	600-29303-1
Pump element 6 including gasket	1	600-26876-2	600-29304-1
Pump element 7 including gasket	1	600-26877-2	600-29305-1
Pump element R including gasket	1	655-28716-1	Not available
Pump element B including gasket	1	600-29185-1	Not available
Pump element C including gasket	1	600-28750-1	Not available

Fig. 27

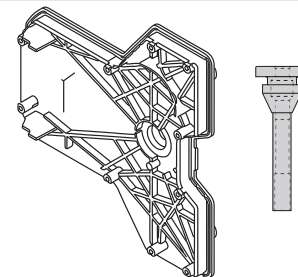

Fig. 28



**14.3 Pressure control valve and adapter**

Designation	Qty.	Part number
Pressure control valve SVTS-350-R 1/4-D6   C3	1	624-28894-1
Pressure control valve SVTS-350-R 1/4-D6   C5-M	1	624-29343-1
Pressure control valve SVET-350-G 1/4 A-D8   C3	1	624-29054-1
Pressure control valve SVTSV-270-R1/4-1/8NPTFI-NIP00R-A   C3	1	270864
Adapter S2520 1/4 -1/4 with PTFE sealing	1	226-14105-5



Further pressure control valves in C3 and C5-M on request

**14.4 Adapter D 6 AX 1/8NPT | C**

Designation	Qty.	Part number
Adapter for pressure control valve 270864   C3	1	304-19614-1

**14.5 Motor 12/ 24 V DC**

Designation	Qty.	Part number
Motor 12 V DC	1	544-36913-6
Power supply 24 V DC	1	544-36913-7

Delivery including 1 x motor connection for control PCB; 2 x O-ring 142 x 4; 3 x O-ring 6 x 2; 1 x radial shaft seal; 3 x screw M6 x 25 self-tapping; 3 x washer; 1 x spring washer; 1 x housing cover with drain hose and corresponding number of screws for installation

Fig. 29



Fig. 30

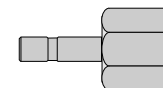
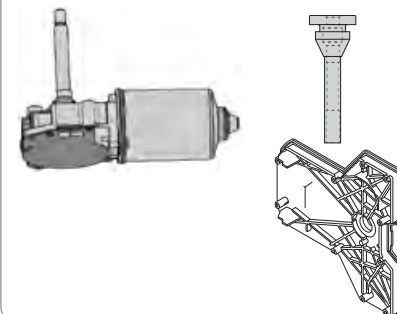

Fig. 31



**14.6 Magnetic switch normally open (NO)**

Designation	Qty.	Part number
Magnetic switch normally open (NO) for intermittent low-level indication	1	544-60277-1

Delivering including housing cover, drain hose, and the corresponding number of screws required for installation

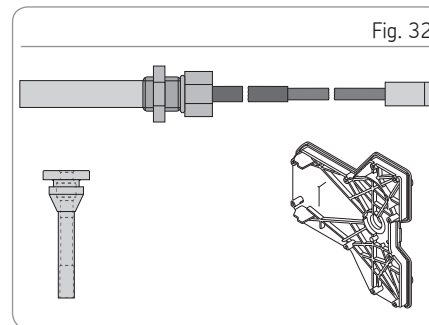
**14.7 Adapter with lubrication fitting**

Designation	Qty.	Part number
Adapter with lubrication fitting ST 1/4 NPTF including gasket	1	519-33840-1
Adapter with lubrication fitting A2 AR 1/4 including gasket	1	519-33959-1
Adapter with lubrication fitting ST AR 1/4 including gasket	1	519-33955-1

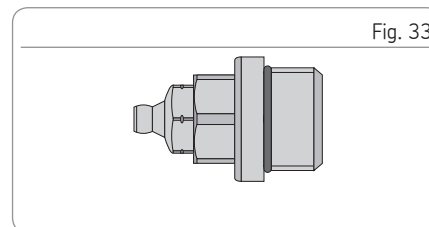
**14.8 Closure screw M22 x 1,5**

Designation	Qty.	Part number
Closure screw M22x 1,5 including gasket	1	519-60445-1

Serves to close an unneeded outlet, e.g. if a pump element is removed.

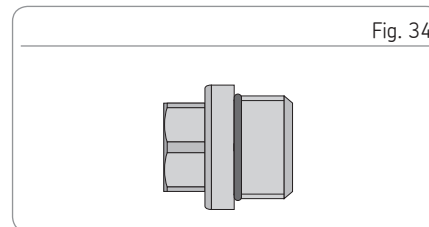



## 14.9 Transparent reservoir

Designation	Qty.	Part number
2 l XNFL <sup>B,C</sup>	1	544-31997-1
2 l XN <sup>A,B,C</sup>	1	544-31996-1
2 l XL (with stirring paddle) <sup>A,B,C</sup>	1	544-32028-1
2 l XN/YNBO <sup>A,B,C,D,E</sup>	1	544-31940-1
2 l XLBO (without stirring paddle) <sup>A,B,C,D,E</sup> (Fig. similar 544-31940-1)	1	544-32027-1
4 l XNBO/YNBO/XLBO/YLBO/XBF <sup>A,B,C</sup>	1	544-31998-1
4 l XN/XL <sup>A,B,C</sup>	1	544-32695-1
8 l XNBO/YNBO/XLBO/YLBO/XBF <sup>A,B,C</sup>	1	544-31999-1
8 l XN/XL <sup>A,B,C,D</sup>	1	544-32696-1

Delivery including: A = Lincoln/SKF Logo; B = Directional arrow; C = O-ring; D = Reservoir lid;  
E = Warning label 'Crushing hazard'



Other transparent reservoirs on request

Fig. 35

544-31997-1



544-31996-1



544-32028-1

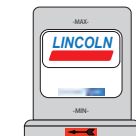

544-31940-1



544-31998-1



544-32695-1



544-31999-1



544-32696-1



### 14.10 Replacement kit control PCB

Designation	Qty.	Part number
Replacement kit control PCB V1x P203	1	544-60217-1
Replacement kit control PCB V2x P203	1	544-60218-1

Delivering including housing cover, drain hose, and the corresponding number of screws required for installation

Fig. 36

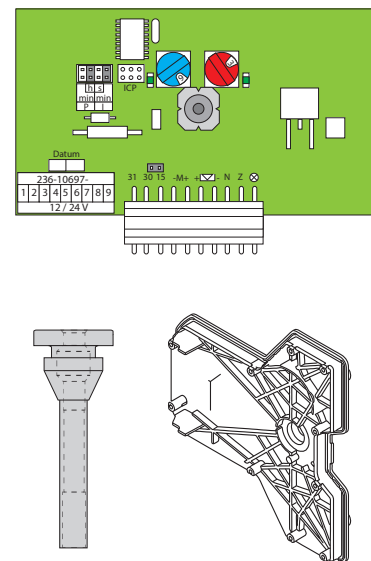

**14.11 Fixed paddle**

Designation	Qty.	Part number
Fixed paddle 4 XNBO	1	444-70490-1
Fixed paddle 8 XNBO	1	444-70491-1

Fig. 37

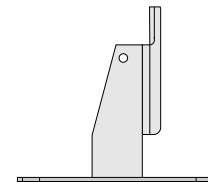
**14.12 Reservoir lid**

Designation	Qty.	Part number
A) Reservoir lid 4/8l [1.06/2.11 gal.] XNBA/XLBA	1	544-36963-1
B) Reservoir lid 4/8l [1.06/2.11 gal.]	1	544-31992-1

Fig. 38

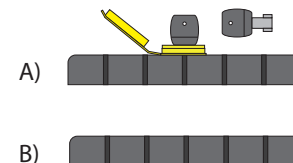

- A) Lockable reservoir lid; including 2 keys and warning label  
 B) Including warning label

**14.13 Screw cap**

Designation	Qty.	Part number
Screw cap at pump housing	1	544-32851-1

Fig. 39



## 14.14 Connection sockets and cable

Feature*	Designation	Qty.	Part number
1	Connection socket <sup>H)</sup> with gasket and screw	1	544-32850-1
2	Connection socket <sup>K)</sup> with gasket and screw	1	544-33843-1
A	Connection cable 10 m [33 ft.] with connection socket <sup>H)</sup>	1	664-36078-7
C	Connection cable 10 m [33 ft.] ADR with connection socket <sup>H)</sup>	1	664-36862-1
E	Connection cable 10 m [33 ft.] with bayonet socket (7/5 poles)	1	664-34167-2
G	Connection cable 10 m [33 ft.] with bayonet socket (7/7 poles)	1	664-34428-3
B	Connection cable 10 m [33 ft.] with connection socket <sup>K)</sup>	1	664-36078-9
D	Connection cable 10 m [33 ft.] ADR with connection socket <sup>H)</sup>	1	664-36862-2
L	Connection cable 06 m [20 ft.] with connection socket <sup>H)</sup>	1	664-36862-8

\*Feature in type identification code (category K connection material)

H) = black

K) = grey

Feature*	Degree of protection (IEC 60529)
1	IP 65
2	IP 65
A	IP 67
C	IP 65
E	IP 6K9K
G	IP 6K9K
B	IP 67
D	IP 65
L	IP 67

Fig. 40

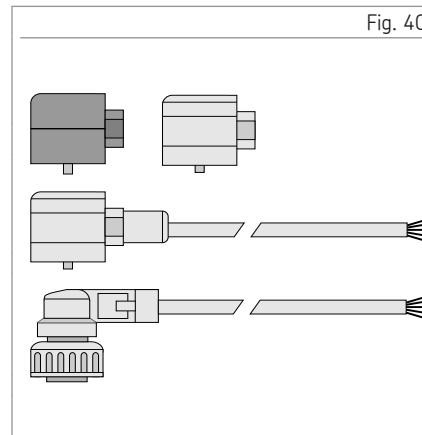

## 15. Electrical connections

### 15.1 Cable colours following IEC 60757

Abbreviation	Colour	Abbreviation	Colour	Abbreviation	Colour	Abbreviation	Colour
BK	black	GN	green	WH	white	PK	pink
BN	brown	YE	yellow	OG	orange	TQ	turquoise
BU	blue	RD	red	VT	violet	-----	-----



The assignment of the following electrical connection diagrams is done according to the respective referenced type identification code characteristics. For the complete type identification code of the P203 pumps, see instructions, chapter 4 Technical data.

## 15.2 Connection of signal line to reservoir lid

Connection of the signal with the square plug to reservoir lid Fig. 41

Connection diagram (lubrication grease) Magnetic switch Low-level indication		Connection diagram (lubrication grease) Magnetic switch high- and low-level indication		Connection diagram (lubricating oil) Float magnetic switch Low-level indication	
Depiction of unactuated condition					
Maximum switching capacity	60 VA	Maximum switching capacity	60 VA	Maximum switching capacity	60 VA
Maximum switching voltage	30 V DC	Maximum switching voltage	30 V DC	Maximum switching voltage	230V
Maximum switching current	700 mA	Maximum switching current	700 mA	Maximum switching current	1 A
L2 = High level   L1 = Low level					

### 15.3 Recommended contact protection measure for switching inductive loads

Recommended contact protection measure for switching inductive loads Fig. 42

For protection of the relay contacts the following contact protection measure should be carried out by the operator.

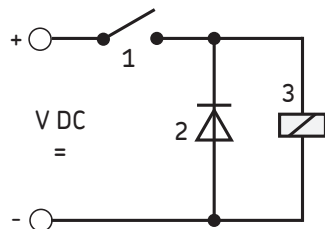

- 1 Magnetic switch
- 2 Interference suppression diode
- 3 Load

15.4 Connection diagram P203 V DC with control PCB V, 1 of 6

Connection diagram P203 V DC with control PCB V Fig. 43

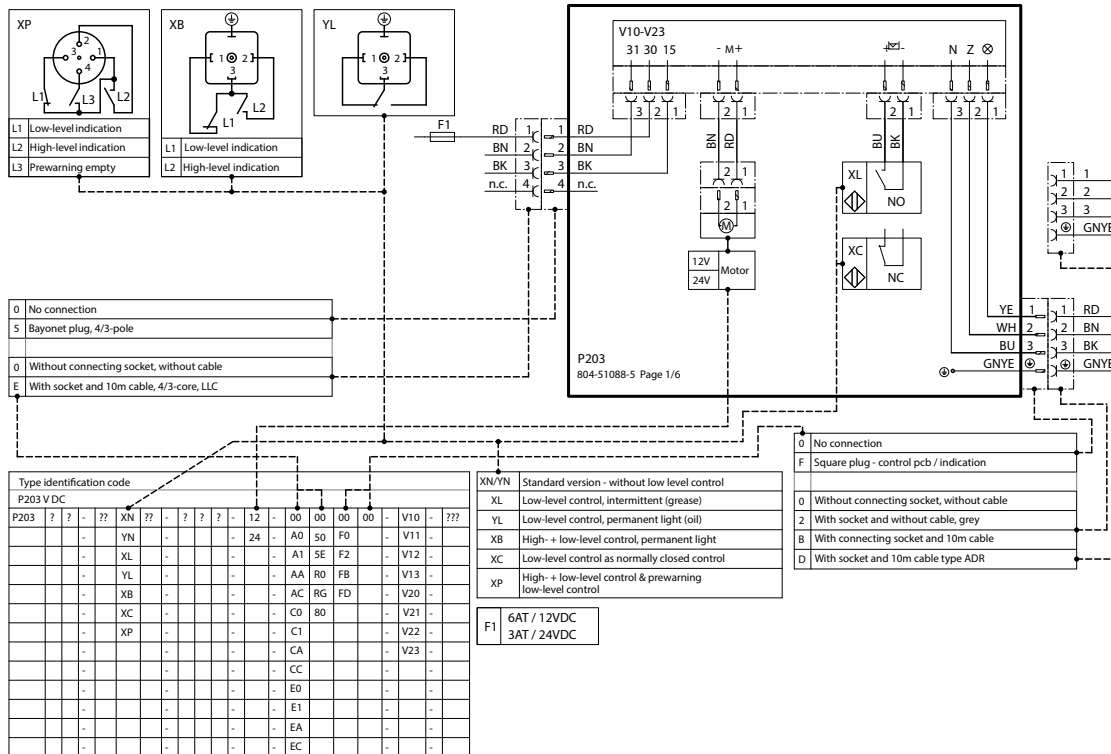



15.5 Connection diagram P203 V DC with control PCB V, 2 of 6

Connection diagram P203 V DC with control PCB V Fig. 44

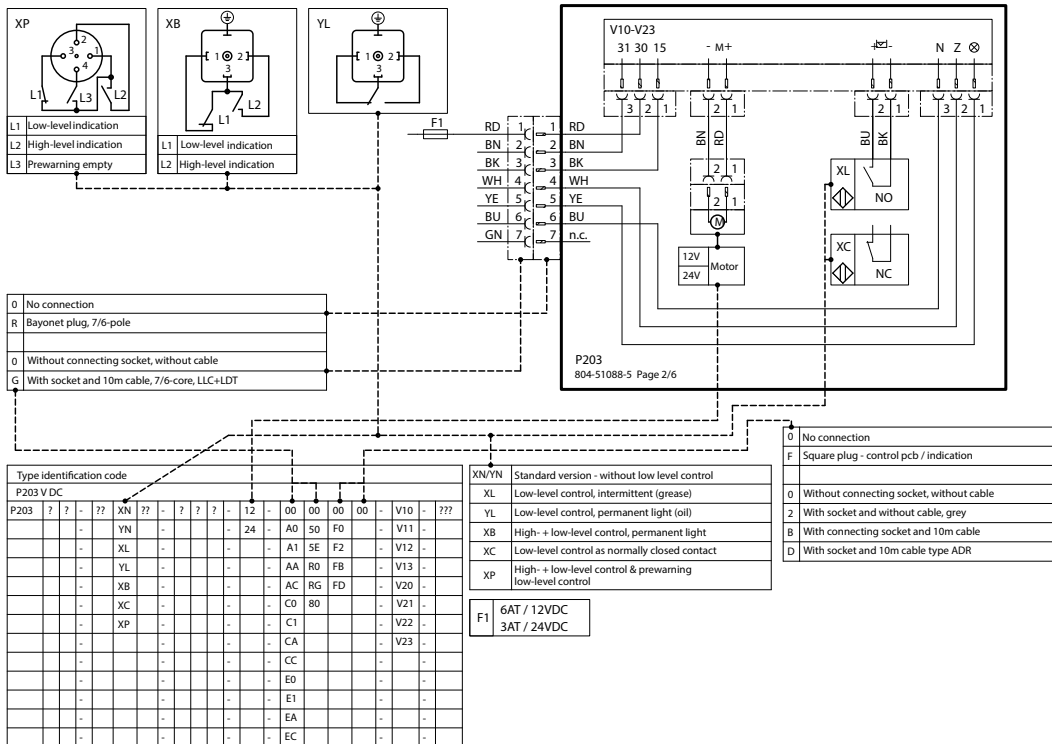

15.6 Connection diagram P203 V DC with control PCB V, 3 of 6

Connection diagram P203 V DC with control PCB V Fig. 45

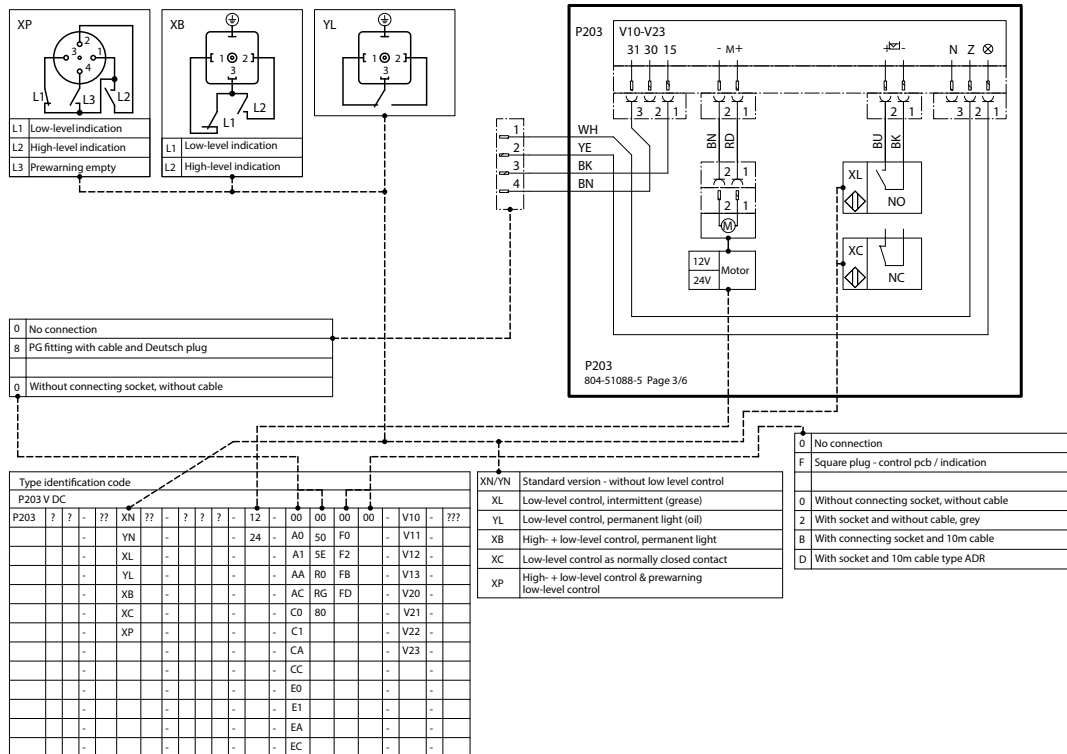

15.7 Connection diagram P203 V DC with control PCB V, 4 of 6

Connection diagram P203 V DC with control PCB V Fig. 46

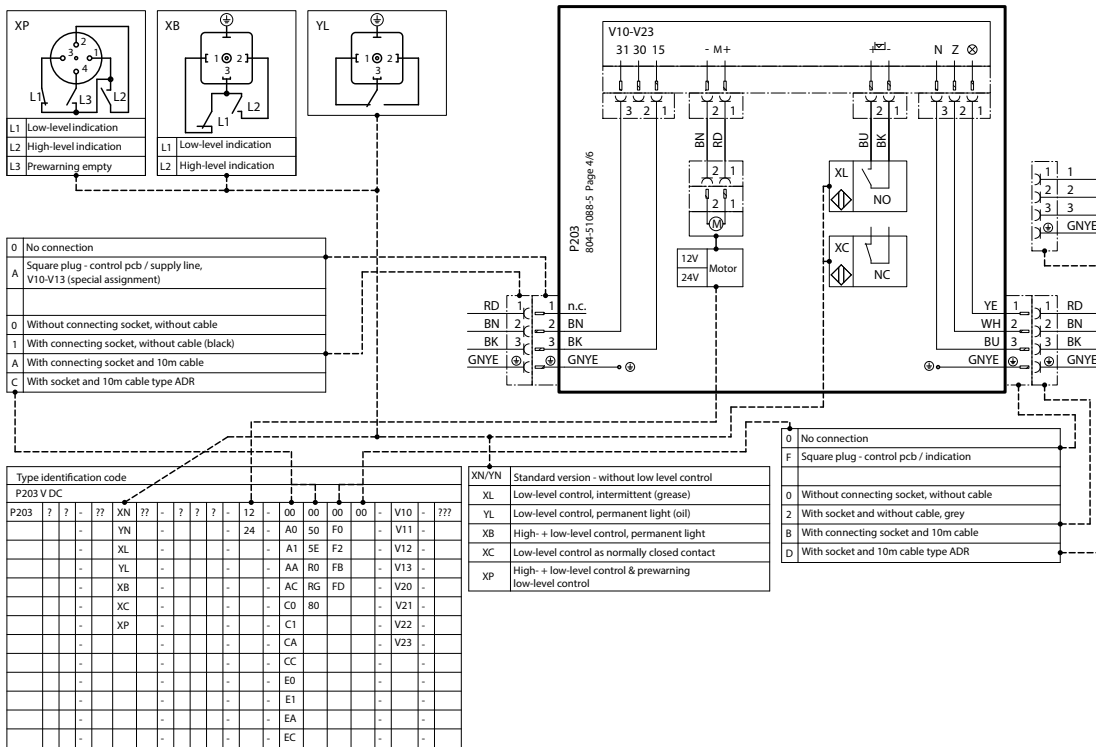

15.8 Connection diagram P203 V DC with control PCB V, 5 of 6

Connection diagram P203 V DC with control PCB V Fig. 47

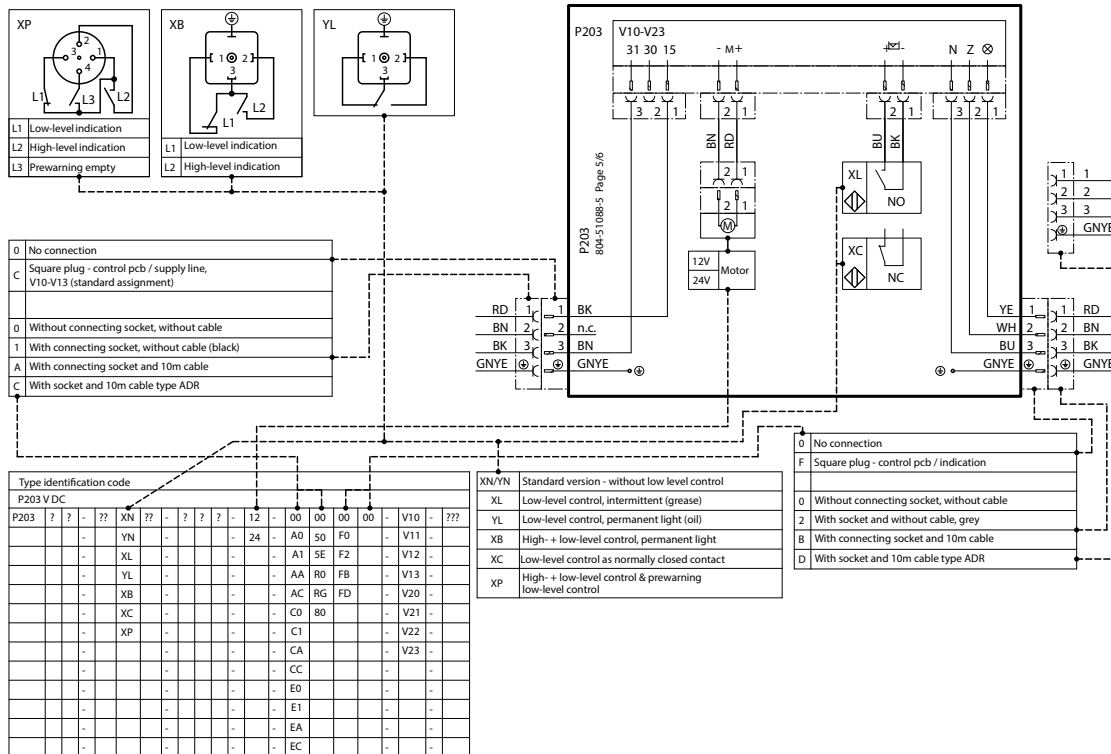

15.9 Connection diagram P203 V DC with control PCB V, 6 of 6

Connection diagram P203 V DC with control PCB V Fig. 48

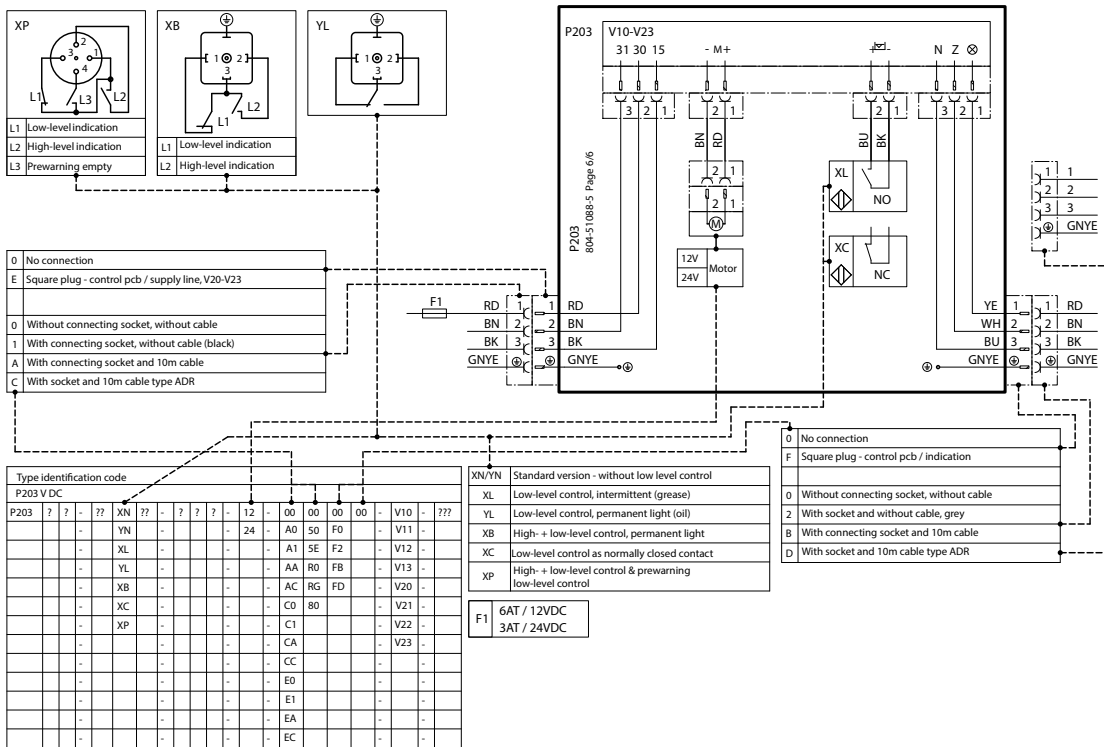

## Notes

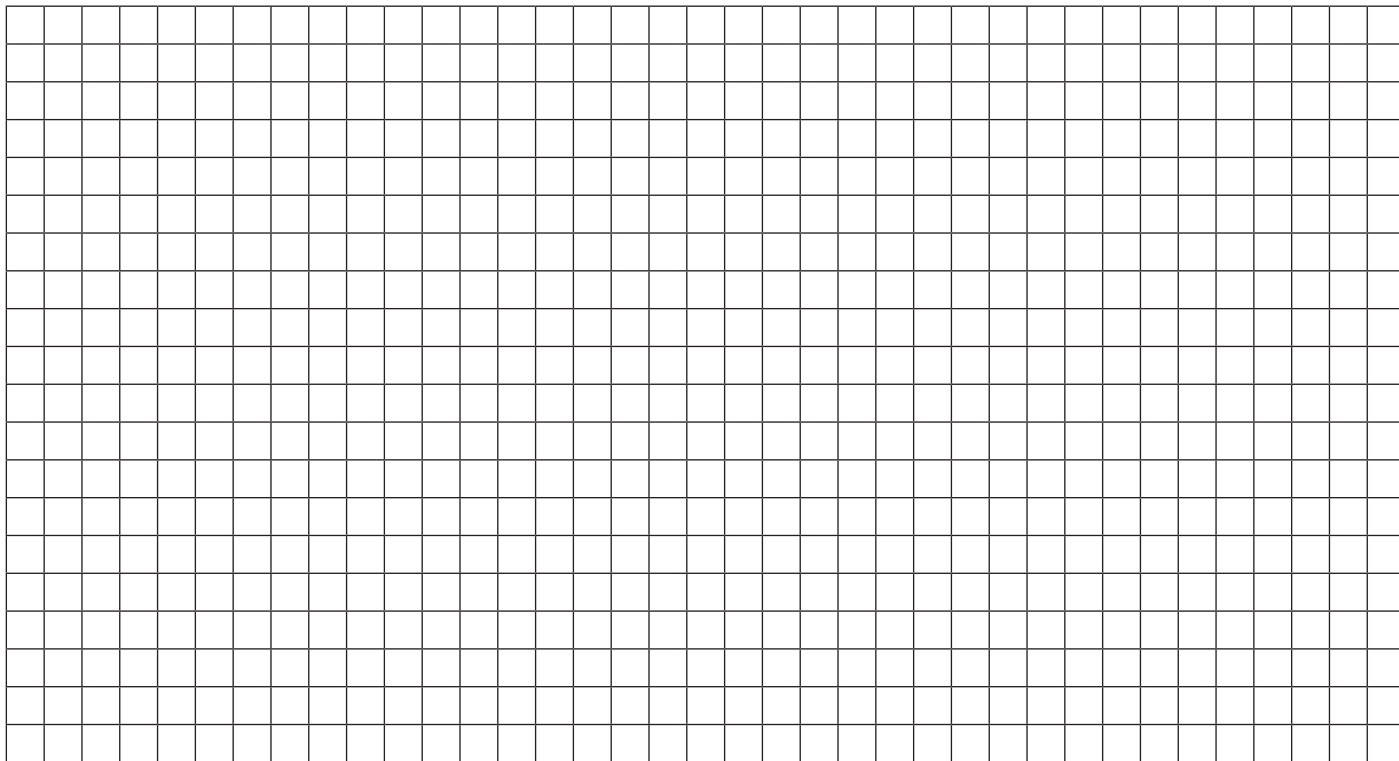

## Notes

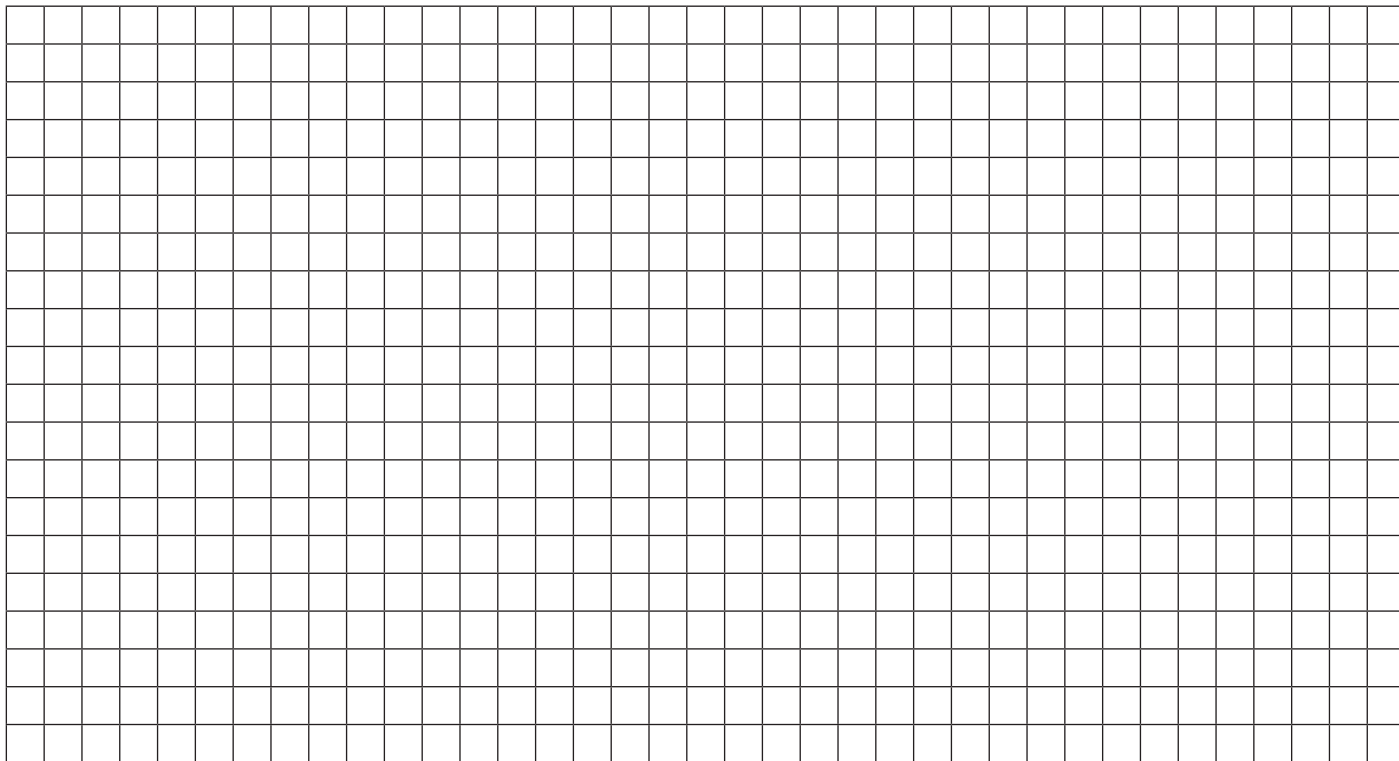

SKF Lubrication Systems Germany GmbH  
Walldorf Facilities  
Heinrich-Hertz-Straße 2-8  
DE - 69190 Walldorf  
Phone: +49 (0) 6227 33-0  
Fax: +49 (0) 6227 33-259  
e-mail: [Lubrication-germany@skf.com](mailto:Lubrication-germany@skf.com)  
[www.skf.com/lubrication](http://www.skf.com/lubrication)

951-171-023-EN  
Version 01  
28/03/2018

